

# 2026 EDCO PRODUCTS PRODUCT GUIDE

Siding | Roofing | Rainware | Soffit | Fascia | Trim



# GENERAL TERMS AND CONDITIONS



**I. SPECIAL ORDERS** A "Special Order" is defined as a product not stocked by EDCO or any product that is custom-made by EDCO to the customer's specifications. These orders are non-returnable, and all sales are final. The customer's signature is required on the order confirmation, and will not be made or ordered until EDCO has received the signed confirmation. Product must be picked up (or delivered) within 30 days of the order being ready at EDCO. Failure to do so will result in a 5% storage fee for every month the product remains in our facility.

**II. DELIVERY - F.O.B. HOPKINS, MN.**

Upon due tender of goods all risk or damage and incidents of ownership pass to the Purchaser but EDCO retains a security interest in the goods until purchase price is paid. Weights shown are approximate.

**III. TAXES**

Prices do not include any state or local sales, use, operational or license taxes or any tax imposed on the use or sale of the material involved.

**IV. RETURNS**

All sales are final. Returned goods will not be accepted without first providing a list of material(s) as well as one of the following: (1) Original invoice, (2) Original order number, (3) Original purchase order number. Once this information has been received, and the requested material return is within the policy outlined below, EDCO will issue a Return Material Authorization (RMA) form. Returns are only valid 90-days after the original purchase date. After the material(s) have been returned, they will be inspected for count accuracy and integrity. If materials or packaging are deemed unsalable, or they were not included on the material list provided, Edco Products, Inc. reserves the right to dispose of this material.

**V. OFFERING**

EDCO price lists do not constitute an offer to sell and all orders are subject to final acceptance by the Treasurer of EDCO Products, Incorporated.

Hopkins Sales Office:

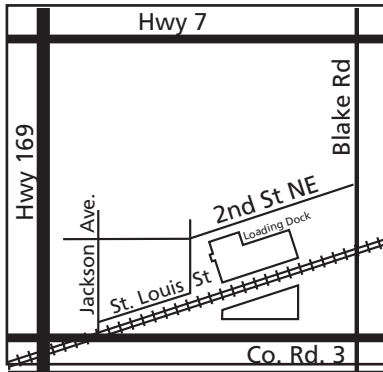

800 Second Street NE  
Hopkins, MN 55343

952.945.2680 Phone  
952.479.9012 Fax  
800.593.2680 Toll-Free

Otsego Sales Office:

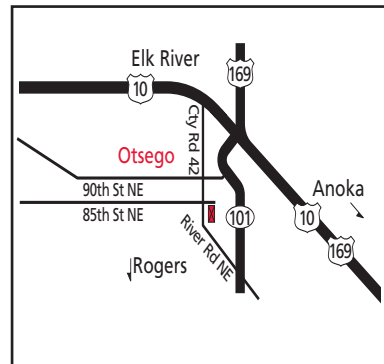

15851 85th Street NE  
Otsego, MN 55330

763.241.4131 Phone  
952.479.3881 Fax  
866.270.4131 Toll-Free

Eagan Sales Office:



2975 Lone Oak Drive, STE 120  
Eagan, MN 55121

651.460.6680 Phone  
952.479.3881 Fax  
866.301.4354 Toll-Free

# TABLE OF CONTENTS

---

|                                       |           |
|---------------------------------------|-----------|
| <b>PERSPECTIVES</b> .....             | <b>2</b>  |
| STEEL SIDING & SOFFIT                 | 2         |
| ACCESSORIES                           | 3         |
| PAINT ACCESSORIES                     | 5         |
| <b>ENDURA</b> .....                   | <b>6</b>  |
| LAP STEEL SIDING                      | 6         |
| VERTICAL STEEL SIDING                 | 7         |
| <b>STEEL SIDING ACCESSORIES</b> ..... | <b>8</b>  |
| TRIM COIL                             | 11        |
| CASING, SILLS, & OTHER TRIMS          | 12        |
| PAINT                                 | 13        |
| NAILS, STAPLES, & FASTENERS           | 14        |
| FASTENERS, NAILS AND STAPLES          | 15        |
| ADHESIVES & SEALANTS                  | 16        |
| SEALANT CROSS-REFERENCE GUIDE         | 17        |
| INSULATION & HOUSEWRAPS               | 18        |
| MOUNTING BLOCKS & VENTS               | 20        |
| MID-AMERICA CROSS-REFERENCE GUIDE     | 21        |
| SHUTTERS                              | 22        |
| VINYL WALL VENTS & LOUVERS            | 23        |
| POLYURETHANE LOUVERS & TRIM           | 24        |
| STAPLES & TOOLS                       | 25        |
| <b>SIDING CHECKLIST</b> .....         | <b>26</b> |
| <b>ARROWLINE</b> .....                | <b>28</b> |
| STEEL SLATE ROOFING                   | 28        |
| STEEL SHAKE ROOFING                   | 29        |
| ROOFING ACCESSORIES                   | 30        |
| ROOFING UNDERLAYMENT                  | 35        |
| SCREWS, NAILS & TOOLS                 | 37        |
| <b>ROOFING ESTIMATION GUIDE</b> ..... | <b>38</b> |
| <b>RAINWARE</b> .....                 | <b>39</b> |
| STEEL                                 | 39        |
| ALUMINUM                              | 40        |
| RAINWARE ACCESSORIES                  | 41        |
| GUTTER COIL                           | 46        |
| SCREWS/NAILS                          | 47        |
| ADHESIVES/SEALANTS                    | 48        |
| TOOLS & ACCESSORIES                   | 50        |
| <b>SOFFIT</b> .....                   | <b>51</b> |
| ACCESSORIES                           | 52        |
| <b>FASCIA</b> .....                   | <b>54</b> |
| STEEL                                 | 54        |
| ALUMINUM, SMOOTH                      | 55        |
| ALUMINUM, WOODGRAIN                   | 56        |
| ACCESSORIES                           | 57        |
| <b>SPECIFICATIONS</b> .....           | <b>58</b> |

# PERSPECTIVES

## STEEL SIDING & SOFFIT



### PRODUCT CODE

#### SHIPLAP SL4

1041-\_\_\_

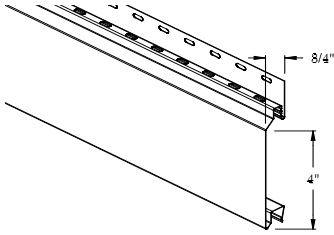

Length: 12'  
 Thickness: 26 Ga.  
 Pieces/Ctn: 12  
 lbs/Ctn: 86  
 Sq.Ft/Ctn: 48  
 Ctns/Skid: 42  
 lbs/Skid: 3,612

#### SHIPLAP SL6

1043-\_\_\_

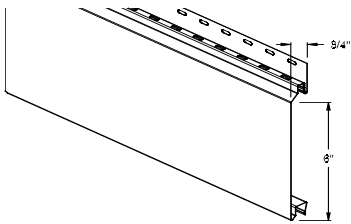

Length: 12'  
 Thickness: 26 Ga.  
 Pieces/Ctn: 8  
 lbs/Ctn: 70  
 Sq.Ft/Ctn: 48  
 Ctns/Skid: 40  
 lbs/Skid: 2,808

|            | Product Code          | 1041 | 1043 |  |
|------------|-----------------------|------|------|--|
|            | Custom Color          | ●    | ●    |  |
| REALGRAIN® | Hickory (1898)        | ●    | ●    |  |
|            | Walnut (1897)         | ●    | ●    |  |
|            | Washed Maple (1899)   | ●    | ●    |  |
| ENTEX®     | Deep Ocean (724)      | ●    | ●    |  |
|            | Glacier White (714)   | ●    | ●    |  |
|            | Iron Gray (719)       | ●    | ●    |  |
|            | Midnight (1111)       | ●    | ●    |  |
|            | Sandtone (712)        | ●    | ●    |  |
|            | Statuary Bronze (713) | ●    | ●    |  |

\* All Perspectives Steel profiles are 48 sq.ft per carton.

# PERSPECTIVES

## STEEL ACCESSORIES



### 7/8" J-CHANNEL PRODUCT CODE **1059-\_\_**

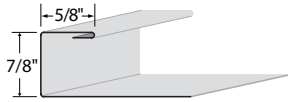

Length: 12'  
 Thickness: 28 Ga.  
 Pieces/Ctn: 25  
 lbs/Ctn: 57  
 Ctns/Skid: 56  
 lbs/Skid: 3,192

### 2 PC 7/8" J-TRIM PRODUCT CODE **1039-\_\_**

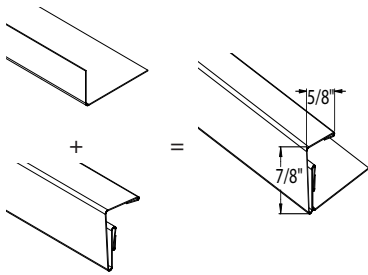

Length: 10'  
 Thickness: 28 Ga.  
 lbs/Ctn: 37  
 Pieces/Ctn: 10

### PERSPECTIVES STARTER STRIP PRODUCT CODE **1064-\_\_**

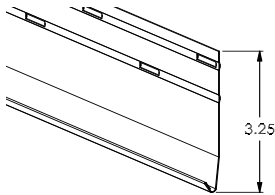

Length: 10'  
 Thickness: 28 Ga.  
 Pieces/Ctn: 20  
 lbs/Ctn: 45  
 Ctns/Skid: 81  
 lbs/Skid: 3,645

### UNDERSILL TRIM PRODUCT CODE **1062-\_\_**

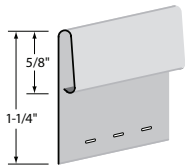

Length: 12'  
 Thickness: 28 Ga.  
 Pieces/Ctn: 25  
 lbs/Ctn: 37

### 2-PC 3.5" WINDOW WRAP PRODUCT CODE **1038-\_\_**

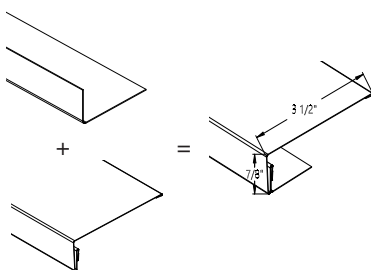

Length: 10'  
 Thickness: 28 Ga.  
 lbs/Ctn: 43  
 Pieces/Ctn: 10

| Product Code          | 1038                | 1039 | 1059 | 1062 | 1064 |
|-----------------------|---------------------|------|------|------|------|
| Custom Color          | ●                   | ●    | ●    | ●    | ●    |
| REALGRAIN®            | Hickory (1898)      | ●    | ●    | ●    | ●    |
|                       | Walnut (1897)       | ●    | ●    | ●    | ●    |
|                       | Washed Maple (1899) | ●    | ●    | ●    | ●    |
| ENTEX®                | Deep Ocean (724)    | ●    | ●    | ●    | ●    |
|                       | Glacier White (714) | ●    | ●    | ●    | ●    |
|                       | Iron Gray (719)     | ●    | ●    | ●    | ●    |
|                       | Midnight (1111)     | ●    | ●    | ●    | ●    |
|                       | Sandtone (712)      | ●    | ●    | ●    | ●    |
| Statuary Bronze (713) | ●                   | ●    | ●    | ●    | ●    |

# PERSPECTIVES

## STEEL ACCESSORIES



---

**SNAP-ON CORNER** **PRODUCT CODE**  
**1068-\_\_**

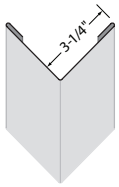

Length: 12'  
 Thickness: 28 Ga.  
 Pieces/Ctn: 10  
 lbs/Ctn: 57

---

**Z-FLASHING** **PRODUCT CODE**  
**1071-\_\_**

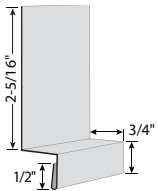

Length: 10'  
 Thickness: 28 Ga.  
 Pieces/Ctn: 25  
 lbs/Ctn: 61

---

**CORNER BASE** **5/8" 1069-000**

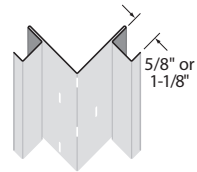

**1-1/8" 1070-000**  
 Length: 12'  
 Thickness: 28 Ga.  
 Pieces/Ctn: 10  
 lbs/Ctn: 51  
 Ctns/Skid: 49  
 lbs/Skid: 2,499

| Product Code                     | 1068 | 1069, 1070 | 1071 |  |
|----------------------------------|------|------------|------|--|
| Custom Color                     | ●    |            | ●    |  |
| No Color (000)                   |      | ●          |      |  |
| <b>REALGRAIN®</b> Hickory (1898) | ●    |            | ●    |  |
| Walnut (1897)                    | ●    |            | ●    |  |
| Washed Maple (1899)              | ●    |            | ●    |  |
| <b>ENTEX®</b> Deep Ocean (724)   | ●    |            | ●    |  |
| Glacier White (714)              | ●    |            | ●    |  |
| Iron Gray (719)                  | ●    |            | ●    |  |
| Midnight (1111)                  | ●    |            | ●    |  |
| Sandtone (712)                   | ●    |            | ●    |  |
| Statuary Bronze (713)            | ●    |            | ●    |  |

# PERSPECTIVES

## PAINT ACCESSORIES



|   | PRODUCT CODE                 |
|---|------------------------------|
| <b>TOUCH-UP PENS</b>  | <b>3400-___</b>              |
|  | Pen (oz): 0.3<br>Pen/Ctn: 25 |

|            | Product Code          | 3400 | Recommended Color Matches for RealGrain |     |     |
|------------|-----------------------|------|---|-----|-----|
| REALGRAIN® | Hickory (1898)        |      | 735                                     | 785 | 711 |
|            | Walnut (1897)         |      | 703                                     | 722 | 711 |
|            | Washed Maple (1899)   |      | 726                                     | 711 |     |
| ENTEX®     | Deep Ocean (724)      | ●    |   |     |     |
|            | Glacier White (714)   | ●    |   |     |     |
|            | Iron Gray (719)       | ●    |   |     |     |
|            | Midnight (1111)       | ●    |   |     |     |
|            | Sandtone (712)        | ●    |   |     |     |
|            | Statuary Bronze (713) | ●    |   |     |     |

\*RealGrain product codes above are the closest match available based on the variety of shades within the grain. Please see additional paint options on Page 13.

# ENDURA

## LAP STEEL SIDING



**DOUBLE 4"** **PRODUCT CODE**  
**1056-\_\_\_\_**

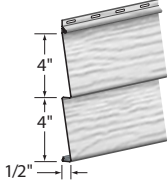

Length: 12'6"  
 Thickness: 28 Ga.  
 Pieces/Ctn: 12  
 lbs/Ctn: 96  
 Ctns/Skid: 40  
 lbs/Skid: 3,840

**DOUBLE 5" DUTCHLAP** **PRODUCT CODE**  
**1049-\_\_\_\_**

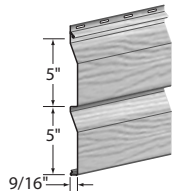

Length: 12'  
 Thickness: 28 Ga.  
 Pieces/Ctn: 10  
 lbs/Ctn: 94  
 Ctns/Skid: 40  
 lbs/Skid: 3,760

**SINGLE 6"** **PRODUCT CODE**  
**1045-\_\_\_\_**



Length: 12'6"  
 Thickness: 28 Ga.  
 Pieces/Ctn: 16  
 lbs/Ctn: 96  
 Ctns/Skid: 40  
 lbs/Skid: 3,840

**SINGLE 8"** **PRODUCT CODE**  
**1051-\_\_\_\_**



Length: 12'6"  
 Thickness: 28 Ga.  
 Pieces/Ctn: 12  
 lbs/Ctn: 97  
 Ctns/Skid: 40  
 lbs/Skid: 3,880

| Product Code         | 1045 | 1049 | 1051 | 1056 |  |
|----------------------|------|------|------|------|--|
| Custom Color         | ●    | ●    | ●    | ●    |  |
| Canyon (786)         | ●    | ●    | ●    | ●    |  |
| Cedarwood (735)      | ●    | ●    | ●    | ●    |  |
| Charcoal Gray (728)  | ●    | ●    | ●    | ●    |  |
| Classic Blue (707)   | ●    | ●    | ●    | ●    |  |
| Classic Red (727)    | ●    | ●    | ●    | ●    |  |
| Claytone (709)       | ●    | ●    | ●    | ●    |  |
| Colonial White (720) | ●    | ●    | ●    | ●    |  |
| Cool Atlantic (731)  | ●    | ●    | ●    | ●    |  |
| Deep Ocean (724)     | ●    | ●    | ●    | ●    |  |
| Desert Tone (718)    | ●    | ●    | ●    | ●    |  |
| Driftwood Gray (726) | ●    | ●    | ●    | ●    |  |
| Glacier White (714)  | ●    | ●    | ●    | ●    |  |
| Iron Gray (719)      | ●    | ●    | ●    | ●    |  |
| Mahogany (785)       | ●    | ●    | ●    | ●    |  |
| Midnight* (1111)     | ●    | ●    | ●    | ●    |  |
| Rustic Brown (722)   | ●    | ●    | ●    | ●    |  |
| Sage (790)           | ●    | ●    | ●    | ●    |  |
| Sand Beige (721)     | ●    | ●    | ●    | ●    |  |
| Sandtone (712)       | ●    | ●    | ●    | ●    |  |
| Still Harbor         | ●    | ●    | ●    | ●    |  |
| Timber (736)         | ●    | ●    | ●    | ●    |  |
| T-Tone (708)         | ●    | ●    | ●    | ●    |  |
| Wickertone (717)     | ●    | ●    | ●    | ●    |  |
| Willow (792)         | ●    | ●    | ●    | ●    |  |

\*Midnight is SMP (ENTEX® without the texture).

\*All ENDURA Steel Lap Siding Profiles include 100 sq.ft per carton.

# ENDURA

## VERTICAL STEEL SIDING



**EMBOSSED VERTICAL 12" BOARD AND BATTEN** **10' 1052-\_\_\_**

Pieces/Ctn: 10

**12'6" 1058-\_\_\_**

Pieces/Ctn: 8

Thickness: 28 Ga.

lbs/Ctn: 91

Ctns/Skid: 30

lbs/Skid: 2,730

\*1058 has extended lead times.

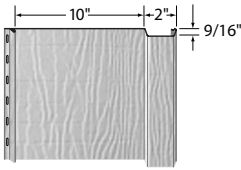

**SMOOTH VERTICAL 12" BOARD AND BATTEN** **10' 1053-\_\_\_**

Pieces/Ctn: 5

**12'6" 1057-\_\_\_**

Pieces/Ctn: 4

Thickness: 26 Ga.

lbs/Ctn: 65

Ctns/Skid: 30

lbs/Skid: 1950

\*1057 has extended lead times.

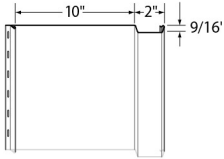

**UNDERSILL TRIM** **1062-\_\_\_**

Length: 12'

Thickness: 28 Ga.

Pieces/Ctn: 25

lbs/Ctn: 37

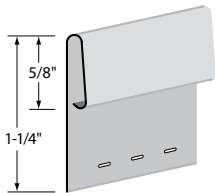

**Z FLASHING FOR VERTICAL SIDING** **1071-\_\_\_**

Length: 10'

Thickness: 28 Ga.

Pieces/Ctn: 25

lbs/Ctn: 61

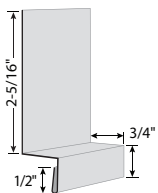

| Product Code          | 1052, 1058 | 1053, 1057 | 1062 | 1071 |  |
|-----------------------|------------|------------|------|------|--|
| Custom Color          | ●          | ●          |      |      |  |
| Black (711)           |            |            | ●    |      |  |
| Canyon (786)          | ●          |            | ●    | ●    |  |
| Cedarwood (735)       | ●          |            | ●    | ●    |  |
| Charcoal Gray (728)   | ●          |            | ●    | ●    |  |
| Classic Blue (707)    | ●          |            | ●    | ●    |  |
| Classic Red (727)     | ●          |            | ●    | ●    |  |
| Claytone (709)        | ●          |            | ●    | ●    |  |
| Colonial White (720)  | ●          |            | ●    | ●    |  |
| Cool Atlantic (731)   | ●          |            | ●    | ●    |  |
| Deep Ocean (724)      | ●          | ●          | ●    | ●    |  |
| Desert Tone (718)     | ●          |            | ●    | ●    |  |
| Driftwood Gray (726)  | ●          |            | ●    | ●    |  |
| Glacier White (714)   | ●          | ●          | ●    | ●    |  |
| Iron Gray (719)       | ●          | ●          | ●    | ●    |  |
| Mahogany (785)        | ●          |            | ●    | ●    |  |
| Midnight* (1111)      | ●          | ●          | ●    | ●    |  |
| Rustic Brown (722)    | ●          |            | ●    | ●    |  |
| Sage (790)            | ●          |            | ●    | ●    |  |
| Sand Beige (721)      | ●          |            | ●    | ●    |  |
| Sandtone (712)        | ●          | ●          | ●    | ●    |  |
| Statuary Bronze (713) |            | ●          | ●    | ●    |  |
| Still Harbor (738)    | ●          |            | ●    | ●    |  |
| Timber (736)          | ●          |            | ●    | ●    |  |
| T-Tone (708)          | ●          |            | ●    | ●    |  |
| Wickertone (717)      | ●          |            | ●    | ●    |  |
| Willow (792)          | ●          |            | ●    | ●    |  |

\*Midnight is SMP (ENTEX® without the texture).

\*Embossed Vertical Steel Siding include 100 sq.ft per carton.

\* Smooth Vertical Steel Siding include 48 sq.ft per carton.

# ENDURA

## STEEL SIDING ACCESSORIES



### 2 PC 7/8" J-TRIM PRODUCT CODE 1039-\_\_

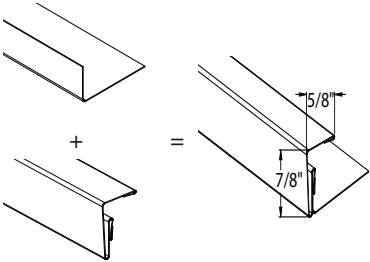

Length: 10'  
 Thickness: 28 Ga.  
 lbs/Ctn: 37  
 Pieces/Ctn: 10

### 5/8" J-CHANNEL PRODUCT CODE 1061-\_\_

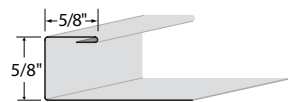

Length: 12'  
 Thickness: 28 Ga.  
 Pieces/Ctn: 25  
 lbs/Ctn: 57  
 Ctns/Skid: 56  
 lbs/Skid: 3,192

### 7/8" J-CHANNEL PRODUCT CODE 1059-\_\_



Length: 12'  
 Thickness: 28 Ga.  
 Pieces/Ctn: 25  
 lbs/Ctn: 57  
 Ctns/Skid: 56  
 lbs/Skid: 3,192

### 1-1/4" J-CHANNEL PRODUCT CODE 1060-\_\_

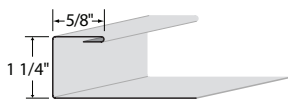

Length: 12'  
 Thickness: 28 Ga.  
 Pieces/Ctn: 25  
 lbs/Ctn: 57  
 Ctns/Skid: 56  
 lbs/Skid: 3,192

### 2-PC 3.5" WINDOW WRAP PRODUCT CODE 1038-\_\_

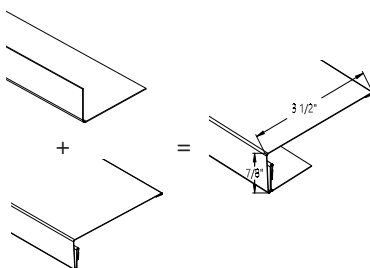

Length: 10'  
 Thickness: 28 Ga.  
 lbs/Ctn: 43  
 Pieces/Ctn: 10

| Product Code                  | 1038 | 1039 | 1059 | 1060 | 1061 |
|-------------------------------|------|------|------|------|------|
| Black (711)                   | ●    | ●    | ●    | ●    | ●    |
| Canyon (786)                  | ●    | ●    | ●    | ●    | ●    |
| Cedarwood (735)               | ●    | ●    | ●    | ●    | ●    |
| Charcoal Gray (728)           | ●    | ●    | ●    | ●    | ●    |
| Classic Blue (707)            | ●    | ●    | ●    | ●    | ●    |
| Classic Red (727)             | ●    | ●    | ●    | ●    | ●    |
| Claytone (709)                | ●    | ●    | ●    | ●    | ●    |
| Colonial White (720)          | ●    | ●    | ●    | ●    | ●    |
| Cool Atlantic (731)           | ●    | ●    | ●    | ●    | ●    |
| Deep Ocean (724)              | ●    | ●    | ●    | ●    | ●    |
| Desert Tone (718)             | ●    | ●    | ●    | ●    | ●    |
| Driftwood Gray (726)          | ●    | ●    | ●    | ●    | ●    |
| Glacier White (714)           | ●    | ●    | ●    | ●    | ●    |
| Iron Gray (719)               | ●    | ●    | ●    | ●    | ●    |
| Mahogany (785)                | ●    | ●    | ●    | ●    | ●    |
| Midnight* (1111)              | ●    | ●    | ●    | ●    | ●    |
| Rustic Brown (722)            | ●    | ●    | ●    | ●    | ●    |
| Sage (790)                    | ●    | ●    | ●    | ●    | ●    |
| Sand Beige (721)              | ●    | ●    | ●    | ●    | ●    |
| Sandtone (712)                | ●    | ●    | ●    | ●    | ●    |
| Still Harbor (738)            | ●    | ●    | ●    | ●    | ●    |
| Timber (736)                  | ●    | ●    | ●    | ●    | ●    |
| T-Tone (708)                  | ●    | ●    | ●    | ●    | ●    |
| Wickertone (717)              | ●    | ●    | ●    | ●    | ●    |
| Willow (792)                  | ●    | ●    | ●    | ●    | ●    |
| RealGrain Hickory (1898)      |      | ●    |      |      |      |
| RealGrain Walnut (1897)       |      | ●    |      |      |      |
| RealGrain Washed Maple (1899) |      | ●    |      |      |      |

\*Midnight is SMP (ENTEX® without the texture).

# ENDURA

## STEEL SIDING ACCESSORIES



**PRODUCT CODE**

**SNAP-ON CORNER POST** **1068-\_\_**

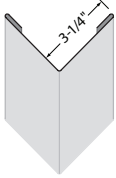

Length: 12'  
Thickness: 28 Ga.  
Pieces/Ctn: 10  
lbs/Ctn: 57

**CORNER BASE** **5/8" 1069-000**

**1-1/8" 1070-000**

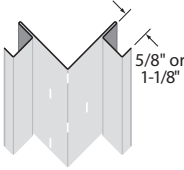

Length: 12'  
Thickness: 28 Ga.  
Pieces/Ctn: 10  
lbs/Ctn: 51  
Ctns/Skid: 49  
lbs/Skid: 2,499

**SNAP-ON FRIEZE TRIM** **1072-\_\_**

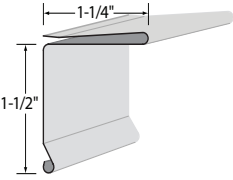

Length: 12'  
Thickness: 28 Ga.  
Pieces/Ctn: 25  
lbs/Ctn: 73



|                    | Product Code            | 1068 | 1069<br>1070 | 1072 |  |
|--------------------|-------------------------|------|--------------|------|--|
|                    | No Color (000)          |      | ●            | ●    |  |
| ENTEX®             | Antique Parchment (715) | ●    |              | ●    |  |
|                    | Black (711)             | ●    |              | ●    |  |
|                    | Canyon (786)            | ●    |              | ●    |  |
|                    | Cedarwood (735)         | ●    |              | ●    |  |
|                    | Charcoal Gray (728)     | ●    |              | ●    |  |
|                    | Classic Blue (707)      | ●    |              |      |  |
|                    | Classic Red (727)       | ●    |              | ●    |  |
|                    | Claytone (709)          | ●    |              | ●    |  |
|                    | Colonial White (720)    | ●    |              | ●    |  |
|                    | Cool Atlantic (731)     | ●    |              | ●    |  |
|                    | Deep Ocean (724)        | ●    |              | ●    |  |
|                    | Desert Tone (718)       | ●    |              | ●    |  |
|                    | Driftwood Gray (726)    | ●    |              | ●    |  |
|                    | Glacier White (714)     | ●    |              | ●    |  |
|                    | Iron Gray (719)         | ●    |              | ●    |  |
|                    | Mahogany (785)          | ●    |              | ●    |  |
|                    | Midnight (1111)         | ●    |              | ●    |  |
|                    | Royal Brown (703)       |      |              | ●    |  |
|                    | Rustic Brown (722)      | ●    |              | ●    |  |
|                    | Sage (790)              | ●    |              |      |  |
| Sand Beige (721)   | ●                       |      | ●            |      |  |
| Sandtone (712)     | ●                       |      | ●            |      |  |
| Still Harbor (738) | ●                       |      | ●            |      |  |
| Timber (736)       | ●                       |      | ●            |      |  |
| T-Tone (708)       | ●                       |      | ●            |      |  |
| Wickertone (717)   | ●                       |      | ●            |      |  |
| Willow (792)       | ●                       |      |              |      |  |
| RealGrain          | Hickory (1898)          | ●    |              | ●    |  |
|                    | Walnut (1897)           | ●    |              | ●    |  |
|                    | Washed Maple (1899)     | ●    |              | ●    |  |

\*Midnight is SMP (ENTEX® without the texture).

# ENDURA

## STEEL SIDING ACCESSORIES

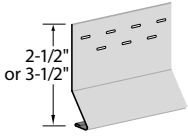
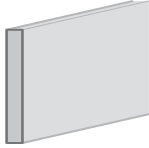
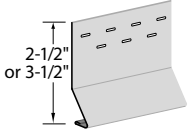
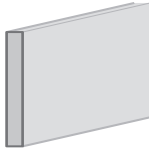
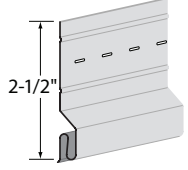
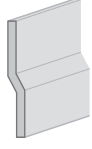

|   | PRODUCT CODE    |  | PRODUCT CODE   |
|---|-----------------|--|--|
| <b>3-1/2" SPRING-LOK STARTER STRIP</b><br> | <b>1065-000</b> | Length: 10'<br>Thickness: 28 Ga.<br>Pieces/Ctn: 20<br>lbs/Ctn: 45<br>Ctns/Skid: 81<br>lbs/Skid: 3,645  | <b>6" FOAM DROP-IN BACKER BOARD</b><br>3010-000<br>Sq Ft/Ctn: 200<br>lbs/Ctn: 10<br>            |
|   | <hr/>           |  |  |
| <b>2-1/2" SPRING-LOK STARTER STRIP</b><br> | <b>1066-000</b> | Length: 10'<br>Thickness: 28 Ga.<br>Pieces/Ctn: 20<br>lbs/Ctn: 26<br>Ctns/Skid: 108<br>lbs/Skid: 2,808 | <b>8" FOAM DROP-IN BACKER BOARD</b><br>3006-000<br>Sq Ft/Ctn: 200<br>lbs/Ctn: 10<br>            |
|   | <hr/>           |  |  |
| <b>2-1/2" STARTER STRIP</b><br>          | <b>1063-000</b> | Length: 10'<br>Thickness: 28 Ga.<br>Pieces/Ctn: 20<br>lbs/Ctn: 42<br>Ctns/Skid: 72<br>lbs/Skid: 3,024  | <b>D4 FOAM DROP-IN BACKER BOARD</b><br>3005-000<br>Sq Ft/Ctn: 200<br>lbs/Ctn: 10<br>           |
|   | <hr/>           |  |  |
|   |                 |  | <b>D5 DUTCHLAP FOAM DROP-IN BACKER BOARD</b><br>3004-000<br>Sq Ft/Ctn: 200<br>lbs/Ctn: 10<br> |

# TRIM COIL



|                 |                 | PRODUCT CODE     |
|-----------------|-----------------|------------------|
| <b>ALUMINUM</b> | <b>Embossed</b> | <b>1372-__</b>   |
|                 | <b>Smooth</b>   | <b>1373-__</b>   |
| 24"             |                 | Length: 50'      |
|                 |                 | Thickness: .019" |
|                 |                 | Pieces/Ctn: 1    |
|                 |                 | lbs/Ctn: 27      |
|                 |                 | Ctns/Skid: 32    |
|                 |                 | lbs/Skid: 864    |

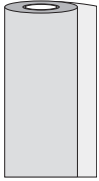

|              |                 | PRODUCT CODE      |
|--------------|-----------------|-------------------|
| <b>STEEL</b> | <b>Embossed</b> | <b>1362-__</b>    |
|              | <b>Smooth</b>   | <b>1363-__</b>    |
| 24"          |                 | Length: 50'       |
|              |                 | Thickness: 30 Ga. |
|              |                 | Pieces/Ctn: 1     |
|              |                 | lbs/Ctn: 56       |
|              |                 | Ctns/Skid: 32     |
|              |                 | lbs/Skid: 1,792   |

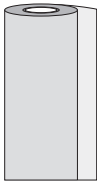

|                                 |  | PRODUCT CODE      |
|---------------------------------|--|-------------------|
| <b>STEEL, SMOOTH, REALGRAIN</b> |  | <b>1369-__</b>    |
| 24"                             |  | Length: 50'       |
|                                 |  | Thickness: 28 Ga. |
|                                 |  | Pieces/Ctn: 1     |
|                                 |  | lbs/Ctn: 45       |
|                                 |  | Ctns/Skid: 32     |
|                                 |  | lbs/Skid: 1,440   |

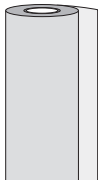

|                       | Product Code            | 1362 | 1363 | 1369 | 1372 | 1373 |
|-----------------------|-------------------------|------|------|------|------|------|
| PVC                   | Polar White (001)       | ●    | ●    |      | ●    | ●    |
|                       | Glacier White (114)     | ●    | ●    |      | ●    | ●    |
|                       | Colonial White (120)    | ●    | ●    |      | ●    | ●    |
| ENTEX®                | Almond Cream (702)      | ●    | ●    |      | ●    | ●    |
|                       | Antique Parchment (715) | ●    | ●    |      | ●    | ●    |
|                       | Black (711)             | ●    | ●    |      | ●    | ●    |
|                       | Canyon (786)            | ●    | ●    |      | ●    | ●    |
|                       | Cedarwood (735)         | ●    | ●    |      | ●    | ●    |
|                       | Charcoal Gray (728)     | ●    | ●    |      | ●    | ●    |
|                       | Classic Blue (707)      | ●    | ●    |      | ●    | ●    |
|                       | Classic Red (727)       | ●    | ●    |      | ●    | ●    |
|                       | Claytone (709)          | ●    | ●    |      | ●    | ●    |
|                       | Colonial White (720)    | ●    | ●    |      | ●    | ●    |
|                       | Deep Ocean (724)        | ●    | ●    |      | ●    | ●    |
|                       | Desert Tone (718)       | ●    | ●    |      | ●    | ●    |
|                       | Driftwood Gray (726)    | ●    | ●    |      | ●    | ●    |
|                       | Glacier White (714)     | ●    | ●    |      | ●    | ●    |
|                       | Hartford Green (706)    | ●    | ●    |      | ●    | ●    |
|                       | Iron Gray (719)         | ●    | ●    |      | ●    | ●    |
|                       | Mahogany (785)          | ●    | ●    |      | ●    | ●    |
|                       | Midnight (1111)         | ●    | ●    |      | ●    | ●    |
|                       | Royal Brown (703)       | ●    | ●    |      | ●    | ●    |
|                       | Rustic Brown (722)      | ●    | ●    |      | ●    | ●    |
|                       | Sage (790)              | ●    | ●    |      | ●    | ●    |
| Sand Beige (721)      | ●                       | ●    |      | ●    | ●    |      |
| Sandtone (712)        | ●                       | ●    |      | ●    | ●    |      |
| Statuary Bronze (713) | ●                       | ●    |      | ●    | ●    |      |
| Timber (736)          | ●                       | ●    |      | ●    | ●    |      |
| T-Tone (708)          | ●                       | ●    |      | ●    | ●    |      |
| Wickertone (717)      | ●                       | ●    |      | ●    | ●    |      |
| Willow (792)          | ●                       | ●    |      | ●    | ●    |      |
| REALGRAIN             | Hickory (1898)          |      |      | ●    |      |      |
|                       | Walnut (1897)           |      |      | ●    |      |      |
|                       | Washed Maple (1899)     |      |      | ●    |      |      |

\*Midnight is SMP (ENTEX® without the texture).

# CASING, SILLS, & OTHER TRIMS



**PRODUCT CODE**  
**1353-\_\_\_**

**7' ALUMINUM BRICK CASING COVER**

Length: 7'  
Thickness: .019"  
Pieces/Ctn: 25  
lbs/Ctn: 19

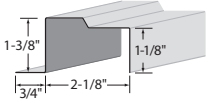

**PRODUCT CODE**  
**1352-\_\_\_**

**12' ALUMINUM BRICK CASING COVER**

Length: 12'  
Thickness: .019"  
Pieces/Ctn: 25  
lbs/Ctn: 33

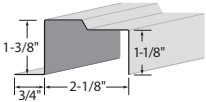

**PRODUCT CODE**  
**1359-\_\_\_**

**ALUMINUM DRIP CAP**

Length: 12'  
Thickness: .019"  
Pieces/Ctn: 25  
lbs/Ctn: 23

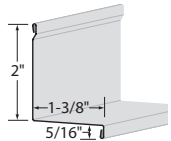

**PRODUCT CODE**  
**1360-\_\_\_**

**STEEL ADJUSTABLE DRIP CAP**

Length: 10'  
Thickness: 28 Ga.  
Pieces/Ctn: 25  
lbs/Ctn: 45

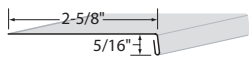

| Product Code          | 1352 | 1353 | 1359 | 1360 |  |
|-----------------------|------|------|------|------|--|
| Polar White (001)     | ●    | ●    | ●    |      |  |
| Black (711)           |      |      | ●    |      |  |
| Canyon (786)          |      |      |      | ●    |  |
| Cedarwood (735)       |      |      |      | ●    |  |
| Charcoal Gray (728)   |      |      |      | ●    |  |
| Classic Blue (707)    |      |      |      | ●    |  |
| Classic Red (727)     |      |      |      | ●    |  |
| Claytone (709)        |      |      |      | ●    |  |
| Colonial White (720)  | ●    |      | ●    | ●    |  |
| Cool Atlantic (731)   |      |      |      | ●    |  |
| Deep Ocean (724)      |      |      | ●    | ●    |  |
| Desert Tone (718)     |      |      |      | ●    |  |
| Driftwood Gray (726)  |      |      |      | ●    |  |
| Glacier White (714)   | ●    |      | ●    | ●    |  |
| Hartford Green (706)  | ●    |      |      |      |  |
| Iron Gray (719)       |      |      | ●    | ●    |  |
| Mahogany (785)        |      |      |      | ●    |  |
| Midnight* (1111)      |      |      |      | ●    |  |
| Royal Brown (703)     | ●    |      |      |      |  |
| Rustic Brown (722)    |      |      |      | ●    |  |
| Sage (790)            |      |      |      | ●    |  |
| Sand Beige (721)      |      |      |      | ●    |  |
| Sandtone (712)        | ●    |      | ●    | ●    |  |
| Still Harbor (738)    |      |      |      | ●    |  |
| Statuary Bronze (713) | ●    |      |      |      |  |
| Timber (736)          |      |      |      | ●    |  |
| T-Tone (708)          | ●    |      |      | ●    |  |
| Wickertone (717)      |      |      |      | ●    |  |
| Willow (792)          |      |      |      | ●    |  |

# PAINT

## SIDING ACCESSORIES



**PRODUCT CODE**

---

**TOUCH-UP PENS** **3400-\_\_\_**

Pen (oz): 0.3  
Pen/Ctn: 25



**PRODUCT CODE**

---

**SPRAY PAINT** **3401-\_\_\_**

Bottle (oz): 12  
Bottle/Ctn: 12



| Product Code            | 3400 | 3401 |  |
|-------------------------|------|------|--|
| Almond Cream (702)      | ●    | ●    |  |
| Antique Parchment (715) | ●    | ●    |  |
| Black (011)             | ●    | ●    |  |
| Canyon (786)            | ●    | ●    |  |
| Cedarwood (735)         | ●    | ●    |  |
| Charcoal Gray (728)     | ●    | ●    |  |
| Classic Blue (707)      | ●    | ●    |  |
| Classic Red (727)       | ●    | ●    |  |
| Claytone (709)          | ●    | ●    |  |
| Colonial White (720)    | ●    | ●    |  |
| Cool Atlantic (731)     | ●    | ●    |  |
| Deep Ocean (724)        | ●    | ●    |  |
| Desert Tone (718)       | ●    | ●    |  |
| Driftwood Gray (726)    | ●    | ●    |  |
| Glacier White (714)     | ●    | ●    |  |
| Hartford Green (706)    | ●    | ●    |  |
| Iron Gray (719)         | ●    | ●    |  |
| Mahogany (785)          | ●    | ●    |  |
| Midnight (1111)         | ●    | ●    |  |
| Polar White (001)       | ●    | ●    |  |
| Royal Brown (703)       | ●    | ●    |  |
| Rustic Brown (722)      | ●    | ●    |  |
| Sage (790)              | ●    | ●    |  |
| Sand Beige (121)        | ●    | ●    |  |
| Sandtone (712)          | ●    | ●    |  |
| Statuary Bronze (713)   | ●    | ●    |  |
| Still Harbor (738)      | ●    | ●    |  |
| Timber (736)            | ●    | ●    |  |
| T-Tone (708)            | ●    | ●    |  |
| Wickertone (717)        | ●    | ●    |  |
| Willow (792)            | ●    | ●    |  |

# NAILS, STAPLES, & FASTENERS

## SIDING ACCESSORIES

|  | PRODUCT CODE      |          |
|--|-------------------|----------|
| <b>NEW 1-1/2" SECUREFAST SIDING #8 SCREW</b> | 1000 Pcs/<br>Ctn: | 3540-000 |
| Depth Setter Bits                            | 1                 |          |
|  | 6000 Pcs/<br>Ctn: | 3541-000 |
| Depth Setter Bits                            | 2                 |          |



|  |                   |          |
|--|-------------------|----------|
| <b>NEW 2" SECUREFAST SIDING #8 SCREW</b> | 550 Pcs/<br>Ctn:  | 3542-000 |
| Depth Setter Bits                        | 1                 |          |
|  | 3800 Pcs/<br>Ctn: | 3543-000 |
| Depth Setter Bits                        | 2                 |          |



|  |          |
|--|----------|
| <b>NEW SECUREFAST 2-PC DEPTH SETTER STICKTIGHT BIT</b> | 3548-000 |
| Pcs/Ctn:   | 2        |



|   |        |          |
|---|--------|----------|
| <b>MAZE DOUBLE HOT-DIP GALVANIZED STEEL NAILS</b> | 2"     | 3417-000 |
| lbs/Ctn:  | 5      |          |
|   | 2"     | 3418-000 |
| lbs/Ctn:  | 50     |          |
|   | 2-1/2" | 3419-000 |
| lbs/Ctn:  | 5      |          |
|   | 2-1/2" | 3420-000 |
| lbs/Ctn:  | 50     |          |
|   | 3"     | 3421-000 |
| lbs/Ctn:  | 5      |          |

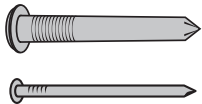

|   | PRODUCT CODE |          |
|---|--------------|----------|
| <b>GRIP-RITE ELECTRO-GALVANIZED NAILS</b> | 50 lbs/Ctn:  | 3427-000 |
|   | 30 lbs/Ctn:  | 3467-000 |
| Length:                                   | 2"           |          |
| 2" Mill Finish                            |              |          |

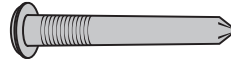

|  |        |          |
|--|--------|----------|
| <b>PASLODE STAPLES OT-2550/OT-2558</b> | 1-3/4" | 3424-000 |
| lbs/Ctn:                               | 27     |          |
|  | 2"     | 3425-000 |
| Length:                                | 2"     |          |
| lbs/Ctn:                               | 26     |          |



Works with 3200-S16P and IM200-S16P.

|   |          |
|---|----------|
| <b>5/16" HAND TACKER GALVANIZED STAPLES</b> | 3422-000 |
| Length:                                     | 5/16"    |
| Pieces/Ctn:                                 | 5000     |
| lbs/Ctn:                                    | 2        |

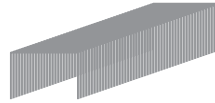

|   |          |
|---|----------|
| <b>COIL NAILS (GALVANIZED RING SHANK)</b> | 3737-000 |
| Length:                                   | 2-1/2"   |
| Pieces/Ctn:                               | 3,200    |
| Coils/Ctn:                                | 16       |
| lbs/Ctn:                                  | 17       |

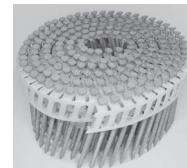

|                                  |        |          |
|----------------------------------|--------|----------|
| <b>STAINLESS STEEL PIN NAILS</b> | 1-3/4" | 3412-000 |
|                                  | 2-1/2" | 3413-000 |
| lbs/Ctn:                         | 5      |          |



# FASTENERS, NAILS AND STAPLES

## SIDING ACCESSORIES

**PRODUCT CODE**  
**MAZE PAINTED STAINLESS STEEL TRIM NAILS** **3279-\_\_\_**  
 Length: 1-1/2"  
 lbs/Ctn: 1



**PRODUCT CODE**  
**MAZE DOUBLE HOT-DIPPED GALVANIZED TRIM NAILS** **3278-\_\_\_**  
 Length: 1-1/2"  
 lbs/Ctn: 1



**PRODUCT CODE**  
**PLEX-CAP ANN-GROOVE GALVANIZED NAIL** **3469-000**  
 Length: 1-3/4"  
 Pieces/Ctn: 2000  
 lbs/Ctn: 9.74



Works with 3200-S16P and IM200-S16P.

| Product Code            | 3278 | 3279 |  |
|-------------------------|------|------|--|
| No Color (000)          |      | ●    |  |
| Antique Parchment (015) | ●    | ●    |  |
| Black (011)             | ●    | ●    |  |
| Canyon (786)            | ●    | ●    |  |
| Cedarwood (735)         | ●    | ●    |  |
| Charcoal Gray (128)     | ●    | ●    |  |
| Classic Blue (007)      | ●    | ●    |  |
| Classic Red (127)       | ●    | ●    |  |
| Claytone (109)          | ●    | ●    |  |
| Deep Ocean (724)        | ●    | ●    |  |
| Desert Tone (118)       | ●    | ●    |  |
| Driftwood Gray (126)    | ●    | ●    |  |
| Glacier White (014)     | ●    | ●    |  |
| Heritage Gray (010)     | ●    | ●    |  |
| Iron Gray (719)         | ●    | ●    |  |
| Mahogany (785)          | ●    | ●    |  |
| Polar White (001)       | ●    | ●    |  |
| Royal Brown (003)       | ●    | ●    |  |
| Sage (790)              | ●    | ●    |  |
| Sand Beige (121)        | ●    | ●    |  |
| Stat Bronze (113)       | ●    | ●    |  |
| Timber (736)            | ●    | ●    |  |
| T-Tone (008)            | ●    | ●    |  |
| Wickertone (117)        | ●    | ●    |  |
| Willow (792)            | ●    | ●    |  |

# ADHESIVES & SEALANTS

## SIDING ACCESSORIES



\*Please reference the Sealant Cross Reference Guide on the next page for these products.

|   |                                       |
|---|---------------------------------------|
| <b>OSI QUAD WINDOW, DOOR &amp; SIDING SEALANT</b> | <b>PRODUCT CODE</b><br><b>3399-__</b> |
|---|---------------------------------------|



Capacity: 1/10 Gal.  
Pieces/Ctn: 12  
lbs/Ctn: 14

|   |                                       |
|---|---------------------------------------|
| <b>NPC SOLAR SEAL WINDOW, DOOR &amp; SIDING SEALANT</b> | <b>PRODUCT CODE</b><br><b>3244-__</b> |
|---|---------------------------------------|



Capacity: 1/10 Gal.  
Pieces/Ctn: 1  
lbs/Ctn: 7.8

|                  |                              |
|------------------|------------------------------|
| <b>OSI VP275</b> | <b>Clear</b> <b>3241-000</b> |
|                  | <b>White</b> <b>3241-001</b> |



Capacity: 10 Oz.  
Pieces/Ctn: 12  
lbs/Ctn: 14

Multi-purpose silicone sealant.

|                      |  |
|----------------------|--|
| <b>OSI QUAD FOAM</b> | <b>PRODUCT CODE</b><br><b>3404-000</b> |
|----------------------|--|



Capacity: 16 Oz.  
Pieces/Ctn: 12  
lbs/Ctn: 12

Window/Door Closed cell, low expansion foam, non rigid.

|                       |                                       |
|-----------------------|---------------------------------------|
| <b>OSI FOAM CLEAN</b> | <b>PRODUCT CODE</b><br><b>3405-__</b> |
|-----------------------|---------------------------------------|



Pieces/Ctn: 12  
lbs/Ctn: 14

|                                     |  |
|-------------------------------------|--|
| <b>APPLICATOR GUN FOR QUAD FOAM</b> | <b>PRODUCT CODE</b><br><b>3406-000</b> |
|-------------------------------------|--|



Pieces/Ctn: 24  
lbs/Ctn: 19

Use with 16oz. Quad cans.

# SEALANT CROSS-REFERENCE GUIDE











| EDCO ENTEX  |                      |      |         | EDCO     | OSI       | NPC             | EDCO PVDF |     |          |  | EDCO | OSI | NPC |
|-------------|----------------------|------|---------|----------|-----------|-----------------|-----------|-----|----------|--|------|-----|-----|
| EDCO ENTEX® | Almond Cream         | 702  | 429     | 52       | EDCO PVDF | Black           | 511       | 003 | 31       |  |      |     |     |
|             | Antique Parchment    | 715  | 457     | 145      |           | Cedar           | 261       | 412 | N/A      |  |      |     |     |
|             | Black                | 711  | 003     | 31       |           | Charcoal Gray   | 228       | 501 | 60       |  |      |     |     |
|             | Canyon               | 786  | 255     | 140      |           | Classic Blue    | 207       | 861 | 272      |  |      |     |     |
|             | Cedarwood            | 732  | 223     | 159      |           | Classic Red     | 227       | 907 | 36       |  |      |     |     |
|             | Charcoal Gray        | 728  | 501     | 60       |           | Copper          | 260       | 000 | N/A      |  |      |     |     |
|             | Classic Blue         | 707  | 861     | 272      |           | Hartford Green  | 206       | 736 | 245      |  |      |     |     |
|             | Classic Red          | 727  | 907     | 36       |           | Pewter          | 216       | 000 | NS - 137 |  |      |     |     |
|             | Claytone             | 709  | 301     | 74       |           | Royal Brown     | 203       | 205 | 33       |  |      |     |     |
|             | Colonial White       | 720  | 004     | 118      |           | Sandtone        | 212       | 301 | N/A      |  |      |     |     |
|             | Cool Atlantic        | 731  | 896     | NS - 75  |           | Statuary Bronze | 213       | 201 | 87       |  |      |     |     |
|             | Deep Ocean           | 724  | N/A     | 242      |           | Stone           | 257       | 889 | N/A      |  |      |     |     |
|             | Desert Tone          | 718  | 450     | 124      |           | T-Tone          | 208       | 219 | 318      |  |      |     |     |
|             | Driftwood Gray       | 716  | 513     | 202      |           |                 |           |     |          |  |      |     |     |
|             | Glacier White        | 714  | 001     | 227      |           |                 |           |     |          |  |      |     |     |
|             | Hartford Green       | 706  | 736     | 245      |           |                 |           |     |          |  |      |     |     |
|             | Heritage Gray        | 710  | 525     | N/A      |           |                 |           |     |          |  |      |     |     |
|             | Iron Gray            | 719  | N/A     | 95       |           |                 |           |     |          |  |      |     |     |
|             | Mahogany             | 785  | 233     | NS - 286 |           |                 |           |     |          |  |      |     |     |
|             | Midnight             | 1111 | 003     | 31       |           |                 |           |     |          |  |      |     |     |
|             | Polar White (Enamel) | 001  | 004     | 118      |           |                 |           |     |          |  |      |     |     |
|             | Royal Brown          | 703  | 205     | 33       |           |                 |           |     |          |  |      |     |     |
|             | Rustic Brown         | 722  | 211     | 46       |           |                 |           |     |          |  |      |     |     |
|             | Sage                 | 790  | 767     | 263      |           |                 |           |     |          |  |      |     |     |
|             | Sand Beige           | 721  | 441     | NS - 11  |           |                 |           |     |          |  |      |     |     |
|             | Sandtone             | 712  | 301     | 74       |           |                 |           |     |          |  |      |     |     |
|             | Statuary Bronze      | 713  | 201     | 87       |           |                 |           |     |          |  |      |     |     |
|             | Still Harbor         | 738  | 827     | NS - 98  |           |                 |           |     |          |  |      |     |     |
| Timber      | 736                  | 293  | 235     |          |           |                 |           |     |          |  |      |     |     |
| T-Tone      | 708                  | 219  | 318     |          |           |                 |           |     |          |  |      |     |     |
| Wickertone  | 717                  | 455  | NS - 13 |          |           |                 |           |     |          |  |      |     |     |
| Willow      | 792                  | N/A  | 237     |          |           |                 |           |     |          |  |      |     |     |

| EDCO RealGrain |              |      |     | EDCO | OSI | NPC |
|----------------|--------------|------|-----|------|-----|-----|
| REALGRAIN      | Hickory      | 1898 | 223 | N/A  |     |     |
|                | Walnut       | 1897 | 233 | 286  |     |     |
|                | Washed Maple | 1899 | 525 | N/A  |     |     |

# INSULATION & HOUSEWRAPS

## SIDING ACCESSORIES

|   | PRODUCT CODE   | PRODUCT CODE  |
|---|--|---|
| <b>GREENGUARD® BY KINGSPAN®<br/>FANFOLD UNDERLAYMENT</b>                            | <b>Plastic/Plastic</b> <b>3636-000</b><br><i>P1450</i><br>Width: 1/4"<br>lbs/Ctn: 11 | <b>GREENGUARD® BY KINGSPAN®<br/>VALUE WRAP</b> <b>9' x 150'</b> <b>3644-000</b><br>Sq.Ft/Roll: 1,350<br>lbs/Ctn: 19<br>Width: 9'                  |
|    | <b>Plastic/Foil</b> <b>3630-000</b><br><i>XFP-14</i><br>Width: 1/4"<br>lbs/Ctn: 11   |   |
|   | <b>Plastic/Plastic</b> <b>3634-000</b><br><i>XP38</i><br>Width: 3/8"<br>lbs/Ctn: 14  | <b>DUPONT FLASHING TAPE</b> <b>4" x 75'</b> <b>3654-000</b><br>Rolls/Ctn: 4<br>Width: 4"  |
|   | <b>Plastic/Foil</b> <b>3632-000</b><br><i>XFP38</i><br>Width: 3/8"<br>lbs/Ctn: 14    | <br><b>9" x 75'</b> <b>3655-000</b><br>Rolls/Ctn: 4<br>Width: 9" |
| Covers 192 sq ft.   |  | 75' length per roll.  |
| <b>GREENGUARD® BY KINGSPAN®<br/>MAX CLASSIC BUILDING WRAP</b>                       | <b>9' x 150'</b> <b>3646-000</b><br>Sq.Ft/Roll: 1,350<br>lbs/Ctn: 20<br>Width: 9'    | <b>RED HOUSEWRAP TAPE</b> <b>3641-000</b><br>Yds/Roll: 55<br>Width: 1 7/8"<br>Rolls/Ctn: 24   |
|  | <b>10' x 150'</b> <b>3645-000</b><br>Sq.Ft/Roll: 1,500<br>lbs/Ctn: 43<br>Width: 10'  |    |
| <b>GREENGUARD® TAPE</b>   | <b>3" x 55'</b> <b>3658-000</b><br>Width: 3"<br>Length: 55 yd.<br>Rolls/Ctn: 12      | <b>TYVEK HOUSEWRAP TAPE</b> <b>2"</b> <b>3657-000</b><br>Rolls/Ctn: 36  |
|  |  | <b>3"</b> <b>3653-000</b><br>Rolls/Ctn: 24  |
|   |  |   |
| <b>GREENGUARD® BY KINGSPAN®<br/>RAINDROP 3D WRAP</b>                                | <b>9' x 125'</b> <b>3649-000</b><br>Sq.Ft/Roll: 1,125<br>lbs/Ctn: 28<br>Width: 7.8   |   |
|  |  |   |

# INSULATION & HOUSEWRAPS

## SIDING ACCESSORIES

|                            | PRODUCT CODE     |                 |
|----------------------------|------------------|-----------------|
| <b>PS x 20 WINDOW TAPE</b> | <b>4" x 100'</b> | <b>3360-000</b> |
|                            | Rolls/Ctn:       | 9               |
|                            | <b>9" x 100'</b> | <b>3361-000</b> |
|                            | Rolls/Ctn:       | 4               |



|                           |                 |
|---------------------------|-----------------|
| <b>WOOD LATH (BUNDLE)</b> | <b>3411-000</b> |
|                           | Bundle/Ctn: 1   |
|                           | lbs/Ctn: 8      |



Bundles only.

|                        |                   |                 |
|------------------------|-------------------|-----------------|
| <b>TYVEK HOUSEWRAP</b> | <b>9' x 150'</b>  | <b>3642-000</b> |
|                        | Sq.Ft/Roll:       | 1,350           |
|                        | lbs/Ctn:          | 19              |
|                        | <b>9' x 100'</b>  | <b>3647-000</b> |
|                        | Sq.Ft/Roll:       | 900             |
|                        | lbs/Ctn:          | 13              |
|                        | <b>10' x 150'</b> | <b>3648-000</b> |
|                        | Sq.Ft/Roll:       | 1,500           |
|                        | lbs/Ctn:          | 19              |



|                                       |                 |                 |
|---------------------------------------|-----------------|-----------------|
| <b>PROTECTO-WRAP SUPER STICK TAPE</b> | <b>4" x 75'</b> | <b>3651-000</b> |
|                                       | Rolls/Ctn:      | 12              |
|                                       | <b>9" x 75'</b> | <b>3652-000</b> |
|                                       | Rolls/Ctn:      | 4               |



# MOUNTING BLOCKS & VENTS

## SIDING ACCESSORIES

|   | PRODUCT CODE                 |
|---|------------------------------|
| <b>STANDARD MOUNT MASTER</b>  | <b>3445-__</b>               |
|  | Pieces/Ctn: 10<br>lbs/Ctn: 6 |

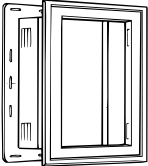
|   | PRODUCT CODE                  |
|---|-------------------------------|
| <b>JUMBO MOUNT MASTER</b>   | <b>3447-__</b>                |
|  | Pieces/Ctn: 10<br>lbs/Ctn: 12 |

|  | PRODUCT CODE                 |
|--|------------------------------|
| <b>MINI MOUNT MASTER</b>   | <b>3446-__</b>               |
|  | Pieces/Ctn: 10<br>lbs/Ctn: 3 |

White, Paintable, Clay, Pewter, Wicker, & Herringbone.

|   | PRODUCT CODE                 |
|---|------------------------------|
| <b>SPLIT-BLOCK MINI</b>   | <b>3439-__</b>               |
|  | Pieces/Ctn: 10<br>lbs/Ctn: 4 |

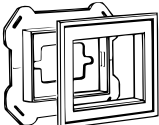
|   | PRODUCT CODE                                       |
|---|--|
| <b>RECESSED MINI-MOUNT MASTER</b>   | <b>Paintable 3444-000</b><br><b>White 3444-301</b> |
|  | Pieces/Ctn: 10<br>lbs/Ctn: 3                       |

White (301) & Paintable (000).

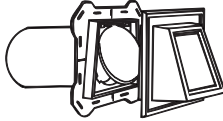
|  | PRODUCT CODE                  |
|--|-------------------------------|
| <b>CLASSIC HOODED DRYER VENT</b>   | <b>4" Vent 3443-__</b>        |
|  | Pieces/Ctn: 1<br>lbs/Ctn: 1.6 |
|  | <b>4" Screen 3464-__</b>      |
|  | <b>6" Vent 3448-__</b>        |
|  | Pieces/Ctn: 1<br>lbs/Ctn: 2.2 |
|  | <b>6" Screen 3465-__</b>      |

Purchase screen separately from vent.

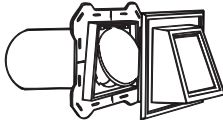
|  | PRODUCT CODE                               |
|--|--|
| <b>CLASSIC HOODED DRYER VENT REPLACEMENT FLAP</b>                                  | <b>3389-__</b>                             |
|  | Width: 4"<br>Pieces/Ctn: 1<br>lbs/Ctn: 1.6 |

White or Paintable.

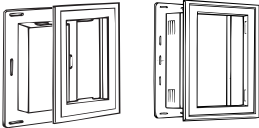
|  | PRODUCT CODE             |
|--|--------------------------|
| <b>UL - ELECTRIC BLOCK</b>   | <b>10 Pieces 3388-__</b> |
|  | lbs/Ctn: 7.5             |
|  | <b>2 Pieces 3388-__</b>  |
|  | lbs/Ctn: 1.5             |
|  | <b>Jumbo 3452-000</b>    |

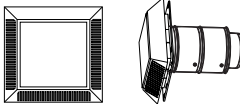
|  | PRODUCT CODE                 |
|--|------------------------------|
| <b>INTAKE EXHAUST VENT</b>   | <b>3387-__</b>               |
|  | Pieces/Ctn: 10<br>lbs/Ctn: 6 |

Accommodates 2" x 6" wall construction and virtually all soffit situations. Comes complete with snap-in modular vent tube system and 4" x 3" reducer.

**\*Please reference the Mid-America Cross-Reference Guide on the next page for these products.**

# MID-AMERICA CROSS-REFERENCE GUIDE



|                    | <b>EDCO ENTEX</b> | <b>EDCO</b> | <b>MID-AMERICA</b> |
|--------------------|-------------------|-------------|--------------------|
| <b>EDCO ENTEX®</b> | Canyon            | 786         | 235                |
|                    | Cedarwood         | 732         | 210                |
|                    | Charcoal Gray     | 728         | 018                |
|                    | Classic Blue      | 707         | 127                |
|                    | Classic Red       | 727         | 027                |
|                    | Claytone          | 709         | 008                |
|                    | Colonial White    | 720         | 001                |
|                    | Cool Atlantic     | 731         | 311                |
|                    | Deep Ocean        | 724         | 913                |
|                    | Desert Tone       | 718         | 071                |
|                    | Driftwood Gray    | 716         | 016                |
|                    | Glacier White     | 714         | 117                |
|                    | Iron Gray         | 719         | 918                |
|                    | Mahogany          | 785         | 204                |
|                    | Midnight          | 1111        | 002                |
|                    | Rustic Brown      | 722         | 032                |
|                    | Sage              | 790         | 120                |
|                    | Sand Beige        | 721         | 012                |
|                    | Sandtone          | 712         | 170                |
|                    | Statuary Bronze   | 713         | 10                 |
| Still Harbor       | 738               | 419         |                    |
| Timber             | 736               | 222         |                    |
| T-Tone             | 708               | 118         |                    |
| Wickertone         | 717               | 069         |                    |
| Willow             | 792               | 405         |                    |

|                  | <b>EDCO RealGrain</b> | <b>EDCO</b> | <b>MID-AMERICA</b> |
|------------------|-----------------------|-------------|--------------------|
| <b>REALGRAIN</b> | Hickory               | 1898        | 210                |
|                  | Walnut                | 1897        | 032                |
|                  | Washed Maple          | 1899        | 16                 |

# SHUTTERS

## SIDING ACCESSORIES

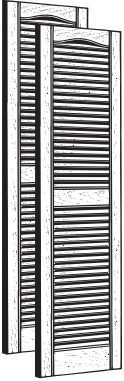

|   | PRODUCT CODE                                    |                    |
|---|---|--------------------|
|  | <b>CATHEDRAL OPEN LOUVER SHUTTER (STYLE L1)</b> | <b>36" 3325-__</b> |
|   |   | <b>39" 3326-__</b> |
|   |   | <b>43" 3327-__</b> |
|   |   | <b>48" 3328-__</b> |
|   |   | <b>52" 3329-__</b> |
|   |   | <b>55" 3330-__</b> |
|   |   | <b>60" 3331-__</b> |
|   |   | <b>64" 3332-__</b> |
|   |   | <b>67" 3333-__</b> |
|   |   | <b>72" 3334-__</b> |

| Product Code      | 3308-3313 | 3325-3334 | 3346 | 3347 |  |
|-------------------|-----------|-----------|------|------|--|
| Primed (000)      | ●         | ●         | ●    | ●    |  |
| Black (011)       | ●         | ●         | ●    | ●    |  |
| Polar White (001) | ●         | ●         | ●    | ●    |  |

Width: 14-1/2" per shutter

|  |  |                    |
|--|--|--------------------|
|  | <b>WILLIAMSBURG RAISED-PANEL SHUTTERS (STYLE P2)</b> | <b>39" 3308-__</b> |
|  |  | <b>43" 3309-__</b> |
|  |  | <b>47" 3310-__</b> |
|  |  | <b>55" 3312-__</b> |
|  |  | <b>59" 3313-__</b> |

Width: 14-3/4" per shutter

|                     |                |
|---------------------|----------------|
| <b>SHUTTER-LOKS</b> | <b>3346-__</b> |
|---------------------|----------------|

Pieces/Bag: 12  
lbs/Ctn: 0.06

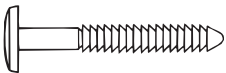

|                       |                |
|-----------------------|----------------|
| <b>SHUTTER SCREWS</b> | <b>3347-__</b> |
|-----------------------|----------------|

Pieces/Bag: 12  
lbs/Ctn: 0.14



# VINYL WALL VENTS & LOUVERS

## SIDING ACCESSORIES

**22" ROUND SCREENED LOUVER** **PRODUCT CODE 3374-\_\_**

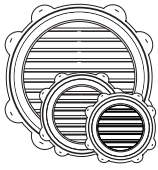

Pieces/Ctn: 1  
lbs/Ctn: 3.9

Exclusive "J" Ring.

**22" x 34" HALF MOON SCREENED LOUVER** **PRODUCT CODE 3375-\_\_**

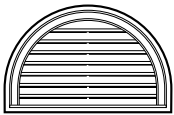

Pieces/Ctn: 1  
lbs/Ctn: 6

Exclusive "J" Ring.

**22" OCTAGON SCREENED LOUVER** **PRODUCT CODE 3384-\_\_**

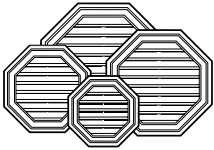

Pieces/Ctn: 1  
lbs/Ctn: 3.6

Exclusive "J" Ring.

**RECTANGULAR SCREENED LOUVER** **12" x 12" PRODUCT CODE 3381-\_\_**

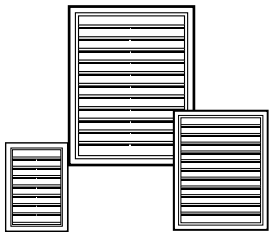

Pieces/Ctn: 5  
lbs/Ctn: 2.5

**12" x 18" PRODUCT CODE 3382-\_\_**

Pieces/Ctn: 5  
lbs/Ctn: 1.7

**18" x 24" PRODUCT CODE 3383-\_\_**

Pieces/Ctn: 5  
lbs/Ctn: 2.6

Exclusive "J" Ring.

| Product Code      | 3374 | 3375 | 3381<br>3382 | 3383 | 3384 |
|-------------------|------|------|--------------|------|------|
| Primed (000)      | •    | •    | •            | •    | •    |
| Claytone (009)    |      |      | •            | •    |      |
| Pewter (016)      |      |      | •            | •    |      |
| Polar White (001) | •    | •    | •            | •    | •    |
| Wickertone (017)  |      |      | •            | •    |      |

# POLYURETHANE LOUVERS & TRIM

## SIDING ACCESSORIES

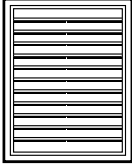

|   | PRODUCT CODE                 |                  |                |
|---|------------------------------|------------------|----------------|
|  | <b>RECTANGULAR LOUVER-LV</b> | <b>18" x 30"</b> | <b>3578-__</b> |
|   |                              | <b>24" x 36"</b> | <b>3582-__</b> |
|   |                              | <b>12" x 30"</b> | <b>3677-__</b> |
|   |                              | <b>12" x 36"</b> | <b>3678-__</b> |
|   |                              | <b>18" x 36"</b> | <b>3679-__</b> |

\*Non-functional. Primed White.

|   |                        |                      |                |
|---|------------------------|----------------------|----------------|
|  | <b>BRACKETS, FYPON</b> | <b>BKT 11" x 20"</b> | <b>3670-__</b> |
|   |                        | <b>BKT 15" x 18"</b> | <b>3671-__</b> |
|   |                        | <b>BKT 17" x 17"</b> | <b>3672-__</b> |
|   |                        | <b>BKT 19" x 24"</b> | <b>3673-__</b> |
|   |                        | <b>BKT 8" x 13"</b>  | <b>3674-__</b> |
|   | Pieces/Ctn:            | 20                   |                |









Primed White.

|   |                      |                |                |
|---|----------------------|----------------|----------------|
|  | <b>DENTIL BLOCKS</b> | <b>6" x 4"</b> | <b>3675-__</b> |
|   |                      | Depth: 6"      |                |

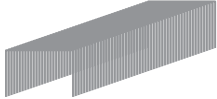
Primed White.

# STAPLES & TOOLS

## SIDING ACCESSORIES

|   | PRODUCT CODE                             |                 | PRODUCT CODE  |
|---|--|-----------------|---|
| <b>PASLODE 3200-S16P</b>  | <b>Sheathing/<br/>Siding<br/>Stapler</b> | <b>3500-000</b> | <b>ZIP REMOVAL TOOL SRT-2</b><br><b>3115-000</b>  |
|    |  |                 |                                |
| <b>5/16" HAND TACKER<br/>GALVANIZED STAPLES</b>                                     |  | <b>3422-000</b> | <b>TRIM NAIL PUNCH TNPZR</b><br><b>3261-000</b>   |
|    | Pieces/Ctn: 5000<br>lbs/Ctn: 2           |                 |                                |
| <b>PASLODE STAPLES<br/>OT-2550/OT-2558</b>  | <b>1-3/4" 3424-000</b><br>lbs/Ctn: 27    |                 | <b>LEFT, RIGHT, OFFSET &amp;<br/>COMBINATION CREWLINE<br/>AVIATION SNIPS</b>                                    |
|    | <b>2" 3425-000</b><br>lbs/Ctn: 26        |                 | <b>AV1 3127-000</b><br><b>AV2 3128-000</b><br><b>AV3 3129-000</b><br><b>AV6 3130-000</b><br><b>AV7 3131-000</b> |
| <b>TENRYU STEEL BLADES</b>  | <b>5-3/8" 56t 3057-000</b><br>Plus X     |                 |                                |
|  | <b>6-1/2" 64t 3056-000</b><br>Plus X     |                 | <b>DUCKBILL SNIPS<br/>MD-12</b><br><b>3122-000</b>  |
|   | <b>7-1/4" 72t 3058-000</b><br>Plus X     |                 |                              |
|   | <b>7-1/4" 48t 3050-000</b><br>Pro        |                 | <b>ANDY™ SNIPS MC14</b><br><b>3133-000</b>  |
|   | <b>10" 50t Pro 3054-000</b>              |                 |   |
|   | <b>12" 60t Pro 3055-000</b>              |                 |   |

For ferrous metal only.

# SIDING CHECKLIST



|  |          |            |              |  |           |            |              |
|--|----------|------------|--------------|--|-----------|------------|--------------|
| <b>PERSPECTIVES</b><br>1 CTN = 48 SQ FT                            |          |            |              | <b>TRIM COIL</b>   |           |            |              |
| SL4  | 1041-    | QTY: _____ | COLOR: _____ | STEEL  | See P. 11 | QTY: _____ | COLOR: _____ |
| SL6  | 1043-    | QTY: _____ | COLOR: _____ | ALUMINUM   | See P. 11 | QTY: _____ | COLOR: _____ |
| <b>ENDURA STEEL SIDING</b><br>1 CTN = 100 SQ FT                    |          |            |              | <b>MOUNTING BLOCKS</b><br>10 PCS/CTN                     |           |            |              |
| D4   | 1056-    | QTY: _____ | COLOR: _____ | MOUNT STANDARD   | 3445-     | QTY: _____ | COLOR: _____ |
| D5DL   | 1049-    | QTY: _____ | COLOR: _____ | MOUNT JUMBO  | 3447-     | QTY: _____ | COLOR: _____ |
| S6   | 1045-    | QTY: _____ | COLOR: _____ | MOUNT MINI   | 3446-     | QTY: _____ | COLOR: _____ |
| S8   | 1051-    | QTY: _____ | COLOR: _____ | SPLIT BLOCK MINI   | 3439-     | QTY: _____ | COLOR: _____ |
| V12  | See P. 7 | QTY: _____ | COLOR: _____ | RECESSED MINI  | 3444-     | QTY: _____ | COLOR: _____ |
| <b>J-CHANNEL</b><br>12'/PC, 300 LF/CTN                             |          |            |              | <b>ELECTRIC BLOCK</b>                                    |           |            |              |
| 5/8"   | 1061-    | QTY: _____ | COLOR: _____ | 4" DRYER VENT  | 3443-     | QTY: _____ | COLOR: _____ |
| 7/8"   | 1059-    | QTY: _____ | COLOR: _____ | 6" DRYER VENT  | 3448-     | QTY: _____ | COLOR: _____ |
| 1-1/4"   | 1060-    | QTY: _____ | COLOR: _____ | INTAKE EXHAUST VENT                                      | 3387-     | QTY: _____ | COLOR: _____ |
| 7/8" 2-PC  | 1039-    | QTY: _____ | COLOR: _____ | <b>VENTS</b><br>1 PC/CTN (INTAKE EXHAUST VENT 10 PC/CTN) |           |            |              |
| <b>WINDOW WRAP</b><br>10'/PC, 50 LF/CTN                            |          |            |              | <b>CAULK</b><br>12 TUBES/CTN                             |           |            |              |
| 3.5", 2PC  | 1038-    | QTY: _____ | COLOR: _____ | OSI QUAD   | 3399-     | QTY: _____ | COLOR: _____ |
| <b>UNDERSILL TRIM (PERSPECTIVES STARTER)</b><br>12'/PC, 300 LF/CTN |          |            |              | <b>TOUCH-UP PENS</b><br>12 PCS/CTN                       |           |            |              |
| 28 Ga.   | 1062-    | QTY: _____ | COLOR: _____ | PENS   | 3400-     | QTY: _____ | COLOR: BARE  |
| <b>CORNER BASE</b><br>12'/PC, 120 LF/CTN                           |          |            |              | <b>NAILS</b>   |           |            |              |
| 5/8"   | 1069-000 | QTY: _____ | COLOR: BARE  | <b>SECUREFAST SCREWS</b> See P. 14 QTY: _____            |           |            |              |
| 1-1/8"   | 1070-000 | QTY: _____ | COLOR: BARE  |  |           |            |              |
| <b>SNAP-ON CORNER POST</b><br>12'/PC, 120 LF/CTN                   |          |            |              |  |           |            |              |
| 28 Ga.   | 1068-    | QTY: _____ | COLOR: _____ |  |           |            |              |
| <b>ENDURA STARTER STRIP</b><br>10'/PC, 200 LF/CTN                  |          |            |              |  |           |            |              |
| EDCO STEEL   | 1063-000 | QTY: _____ | COLOR: BARE  |  |           |            |              |
| 2-1/2" SPRING-LOK  | 1066-000 | QTY: _____ | COLOR: BARE  |  |           |            |              |
| 3-1/2" SPRING-LOK  | 1065-000 | QTY: _____ | COLOR: BARE  |  |           |            |              |
| <b>** USE UNDERSILL TRIM FOR PERSPECTIVES (SEE ABOVE)</b>          |          |            |              |  |           |            |              |

# NOTES

---

---

---

---

---

---

---

---

---

---

---

---

---

---

---

---

---

---

---

---

---

---

---

---

---

# ARROWLINE

## STEEL SLATE ROOFING

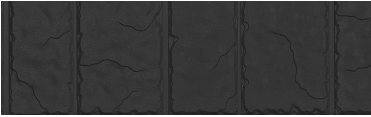
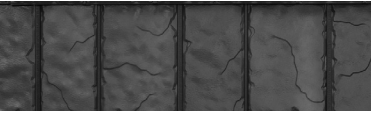
|   |              | PRODUCT CODE |     |
|---|--------------|--------------|-----|
| <b>SLATE<br/>SOLID AND BLEND</b>  | <b>Solid</b> | <b>1748-</b> | ___ |
|   | <b>Blend</b> | <b>1755-</b> | ___ |
|  | Coverage:    | 50"x12"      |     |
|   | Thickness:   | 28 Ga.       |     |
|   | Pieces/Ctn:  | 12           |     |
|   | lbs/Ctn:     | 47           |     |
|  | Ctns/Skid:   | 30           |     |
|   | lbs/Skid:    | 1,410        |     |

PVDF Finish Rough Slate.

|            |                             | Product Code | 1748 | 1755 |  |
|------------|-----------------------------|--------------|------|------|--|
| PVDF SOLID | Black (511)                 |              | ●    |      |  |
|            | Charcoal Gray (228)         |              | ●    |      |  |
|            | Classic Red (227)           |              | ●    |      |  |
|            | Hartford Green (206)        |              | ●    |      |  |
|            | Royal Brown (203)           |              | ●    |      |  |
|            | Statuary Bronze (213)       |              | ●    |      |  |
|            | Stone (257)                 |              | ●    |      |  |
| PVDF BLEND | Charcoal Gray Blend (294)   |              |      | ●    |  |
|            | Classic Red Blend (298)     |              |      | ●    |  |
|            | Royal Brown Blend (296)     |              |      | ●    |  |
|            | Statuary Bronze Blend (292) |              |      | ●    |  |
|            | Stone Blend (299)           |              |      | ●    |  |
|            | T-Tone Blend (293)          |              |      | ●    |  |

# ARROWLINE

## STEEL SHAKE ROOFING



**SHAKE SOLID AND BLEND**

**PRODUCT CODE**  
**Solid 1751-\_\_**  
**Blend 1758-\_\_**

Coverage: 50" x 12"  
 Thickness: 28 Ga.  
 Pieces/Ctn: 12  
 lbs/Ctn: 47  
 Ctns/Skid: 30  
 lbs/Skid: 1,410

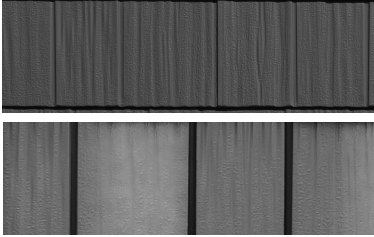

PVDF Finish Cedar-Grain.

**INFINITI**

**PRODUCT CODE**  
**1766-\_\_**

Coverage: 50" x 12"  
 Thickness: 28 Ga.  
 Pieces/Ctn: 12  
 lbs/Ctn: 47  
 Ctns/Skid: 30  
 lbs/Skid: 1,410

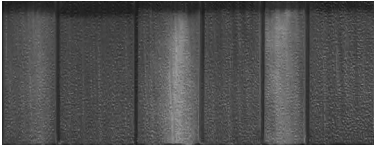

Textured PVDF Finish Cedar-Grain.

**GENERATIONS**

**PRODUCT CODE**  
**1763-\_\_**

Coverage: 50" x 12"  
 Thickness: 28 Ga.  
 Pieces/Ctn: 12  
 lbs/Ctn: 47  
 Ctns/Skid: 30  
 lbs/Skid: 1,410



PVDF Finish Cedar-Grain.

|                               | Product Code                | 1751                          | 1758 | 1763 | 1766 |   |
|-------------------------------|-----------------------------|-------------------------------|------|------|------|---|
| PVDF SOLID                    | Black (511)                 | ●                             |      |      |      |   |
|                               | Cedar (261)                 | ●                             |      |      |      |   |
|                               | Charcoal Gray (228)         | ●                             |      |      |      |   |
|                               | Classic Blue (207)          | ●                             |      |      |      |   |
|                               | Classic Red (227)           | ●                             |      |      |      |   |
|                               | Copper (260)                | ●                             |      |      |      |   |
|                               | Hartford Green (206)        | ●                             |      |      |      |   |
|                               | Pewter (216)                | ●                             |      |      |      |   |
|                               | Royal Brown (203)           | ●                             |      |      |      |   |
|                               | Sandtone (212)              | ●                             |      |      |      |   |
| PVDF BLEND                    | Statuary Bronze (213)       | ●                             |      |      |      |   |
|                               | T-Tone (208)                | ●                             |      |      |      |   |
|                               | Charcoal Gray Blend (294)   |                               | ●    |      |      |   |
|                               | Classic Red Blend (298)     |                               | ●    |      |      |   |
|                               | Hartford Green Blend (295)  |                               | ●    |      |      |   |
|                               | Royal Brown Blend (296)     |                               | ●    |      |      |   |
|                               | Statuary Bronze Blend (292) |                               | ●    |      |      |   |
|                               | T-Tone Blend (293)          |                               | ●    |      |      |   |
|                               | INFINITI                    | Aged Bronze Enhanced (558)    |      |      |      | ● |
|                               |                             | Chestnut Brown Enhanced (556) |      |      |      | ● |
| Granite Gray Enhanced (557)   |                             |                               |      |      | ●    |   |
| Obsidian (599)                |                             |                               |      |      | ●    |   |
| Weathered Wood Enhanced (555) |                             |                               |      |      | ●    |   |
| GENERATIONS                   | Cedar HD (281)              |                               |      | ●    |      |   |
|                               | Charcoal Gray HD (278)      |                               |      | ●    |      |   |
|                               | Classic Red HD (277)        |                               |      | ●    |      |   |
|                               | Copper HD (280)             |                               |      | ●    |      |   |
|                               | Hartford Green HD (266)     |                               |      | ●    |      |   |
|                               | Royal Brown HD (263)        |                               |      | ●    |      |   |
|                               | T-Tone HD (268)             |                               |      | ●    |      |   |

# ARROWLINE

## ROOFING ACCESSORIES



### EAVE STARTER PRODUCT CODE 1721-\_\_

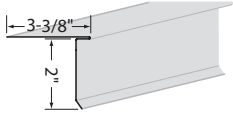

Length: 10'  
 Thickness: 28 Ga.  
 Pieces/Ctn: 10  
 lbs/Ctn: 38

Velvet Embossed.

### 7/8" J-TRIM PRODUCT CODE 1723-\_\_

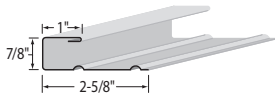

Length: 10'  
 Thickness: 28 Ga.  
 Pieces/Ctn: 10  
 lbs/Ctn: 29

Velvet Embossed.

### HEAD WALL FLASHING PRODUCT CODE 1746-\_\_

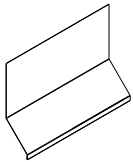

Length: 10'  
 Thickness: 28 Ga.  
 Pieces/Ctn: 5  
 lbs/Ctn: 28

Velvet Embossed.

### RAKE STARTER PRODUCT CODE 1722-\_\_

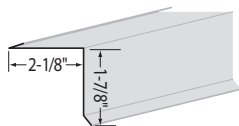

Length: 10'  
 Thickness: 28 Ga.  
 Pieces/Ctn: 10  
 lbs/Ctn: 29

Velvet Embossed.

| Product Code         | 1721                   | 1722 | 1723 | 1746 |   |  |
|----------------------|------------------------|------|------|------|---|--|
| PVDF SOLID           | Aged Bronze (537)      | ●    | ●    | ●    | ● |  |
|                      | Black - Obsidian (511) | ●    | ●    | ●    | ● |  |
|                      | Cedar (261)            | ●    | ●    | ●    | ● |  |
|                      | Charcoal Gray (228)    | ●    | ●    | ●    | ● |  |
|                      | Chestnut Brown (539)   | ●    | ●    | ●    | ● |  |
|                      | Classic Blue (207)     | ●    | ●    | ●    | ● |  |
|                      | Classic Red (227)      | ●    | ●    | ●    | ● |  |
|                      | Copper (260)           | ●    | ●    | ●    | ● |  |
|                      | Granite Gray (538)     | ●    | ●    | ●    | ● |  |
|                      | Hartford Green (206)   | ●    | ●    | ●    | ● |  |
|                      | Pewter (216)           | ●    | ●    | ●    | ● |  |
|                      | Royal Brown (203)      | ●    | ●    | ●    | ● |  |
|                      | Sandtone (212)         | ●    | ●    | ●    | ● |  |
|                      | Statuary Bronze (213)  | ●    | ●    | ●    | ● |  |
|                      | Stone (257)            | ●    | ●    | ●    | ● |  |
|                      | T-Tone (208)           | ●    | ●    | ●    | ● |  |
| Weathered Wood (540) | ●                      | ●    | ●    | ●    |   |  |

# ARROWLINE

## ROOFING ACCESSORIES



**PRODUCT CODE**  
**SIDE WALL FLASHING** **1747-\_\_**

Length: 10'  
Thickness: 28 Ga.  
Pieces/Ctn: 5  
lbs/Ctn: 43

Velvet Embossed.

**QUARRIX® RIDGE VENT WITH FOAM SEAL** **1733-000**

Length: 10'  
Pieces/Ctn: 5  
lbs/Ctn: 25

**STARTER BASE** **With Foam 1724-000**  
lbs/Ctn: 31

**No Foam 1725-000**  
lbs/Ctn: 28  
Length: 10'  
Thickness: 28 Ga.  
Pieces/Ctn: 5

With Foam for non-vented systems.

**STEEL TRIM COIL, EMBOSSED** **1730-\_\_**

Length: 50'  
Thickness: 28 Ga.  
Pieces/Ctn: 1  
lbs/Ctn: 42  
Ctns/Skid: 32  
lbs/Skid: 1,344

Velvet Embossed.

**ARROWLINE ROOFING CLIPS** **Shingle 1741-000**  
**Valley 1742-000**

Length: 1-1/2"  
Thickness: 24 Ga.  
Pieces/Ctn: 50  
lbs/Ctn: 1

Packed 6 bags of 100 ctn each.

|                      | Product Code          | 1730 | 1747 |  |
|----------------------|-----------------------|------|------|--|
| PVDF SOLID           | Aged Bronze (537)     | ●    | ●    |  |
|                      | Black- Obsidian (511) | ●    | ●    |  |
|                      | Cedar (261)           | ●    | ●    |  |
|                      | Charcoal Gray (228)   | ●    | ●    |  |
|                      | Chestnut Brown (539)  | ●    | ●    |  |
|                      | Classic Blue (207)    | ●    | ●    |  |
|                      | Classic Red (227)     | ●    | ●    |  |
|                      | Copper (260)          | ●    | ●    |  |
|                      | Granite Gray (538)    | ●    | ●    |  |
|                      | Hartford Green (206)  | ●    | ●    |  |
|                      | Pewter (216)          | ●    | ●    |  |
|                      | Royal Brown (203)     | ●    | ●    |  |
|                      | Sandtone (212)        | ●    | ●    |  |
|                      | Statuary Bronze (213) | ●    | ●    |  |
|                      | Stone (257)           | ●    | ●    |  |
|                      | T-Tone (208)          | ●    | ●    |  |
| Weathered Wood (540) | ●                     | ●    |      |  |

# ARROWLINE

## ROOFING ACCESSORIES



### RIDGE/HIP CAP, SOLID COLORS

**PRODUCT CODE**  
**Slate 1750-\_\_\_**  
**Shake 1752-\_\_\_**  
 Length: 12"  
 Thickness: 28 Ga.  
 Pieces/Ctn: 20  
 lbs/Ctn: 14  
 Ctns/Skid:  
 lbs/Skid:

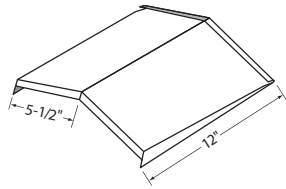

### VALLEY CAP BLACK FILTER FOAM

**PRODUCT CODE**  
**3725-000**  
 Length: 6'-6"  
 Pieces/Ctn: 30  
 lbs/Ctn: 13

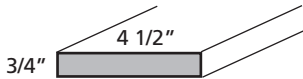

### VALLEY FLASHING

**PRODUCT CODE**  
**1727-\_\_\_**  
 Length: 10'  
 Thickness: 28 Ga.  
 Pieces/Ctn: 5  
 lbs/Ctn: 59

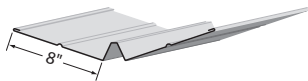

### VALLEY CAP

**PRODUCT CODE**  
**1734-\_\_\_**  
 Length: 10'  
 Thickness: 28 Ga.  
 Pieces/Ctn: 5  
 lbs/Ctn: 20

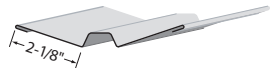

Use with Valley Flashing #1727-\_\_\_.

| Product Code          | 1727 | 1734 | 1750 | 1752 |  |
|-----------------------|------|------|------|------|--|
| Aged Bronze (537)     | ●    | ●    |      |      |  |
| Black- Obsidian (511) | ●    | ●    | ●    | ●    |  |
| Cedar (261)           | ●    | ●    |      | ●    |  |
| Charcoal Gray (228)   | ●    | ●    | ●    | ●    |  |
| Chestnut Brown (539)  | ●    | ●    |      |      |  |
| Classic Blue (207)    | ●    | ●    |      | ●    |  |
| Classic Red (227)     | ●    | ●    | ●    | ●    |  |
| Copper (260)          | ●    | ●    |      | ●    |  |
| Granite Gray (538)    | ●    | ●    |      |      |  |
| Hartford Green (206)  | ●    | ●    | ●    | ●    |  |
| Pewter (216)          | ●    | ●    |      | ●    |  |
| Royal Brown (203)     | ●    | ●    | ●    | ●    |  |
| Sandtone (212)        | ●    | ●    |      | ●    |  |
| Statuary Bronze (213) | ●    | ●    | ●    | ●    |  |
| Stone (257)           | ●    | ●    | ●    |      |  |
| T-Tone (208)          | ●    | ●    |      | ●    |  |
| Weathered Wood (540)  | ●    | ●    |      |      |  |

PVDF SOLID

# ARROWLINE

## ROOFING ACCESSORIES



**RIDGE/HIP CAP, ENHANCED COLORS**

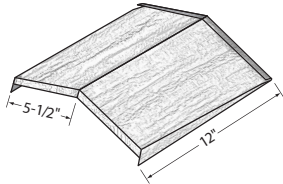

**PRODUCT CODE**

**Slate** 1757-\_\_

**Shake** 1768-\_\_

**Infiniti** 1767-\_\_

**Generations** 1764-\_\_

Length: 12"

Thickness: 28 Ga.

Pieces/Ctn: 20

lbs/Ctn: 18

| Product Code |                               | 1757 | 1764 | 1767 | 1768 |  |
|--------------|-------------------------------|------|------|------|------|--|
| PVDF BLEND   | Charcoal Gray Blend (294)     | ●    |      |      | ●    |  |
|              | Classic Red Blend (298)       | ●    |      |      | ●    |  |
|              | Hartford Green Blend (295)    |      |      |      | ●    |  |
|              | Royal Brown Blend (296)       | ●    |      |      | ●    |  |
|              | Statuary Bronze Blend (292)   | ●    |      |      | ●    |  |
|              | Stone Blend (299)             | ●    |      |      |      |  |
|              | T-Tone Blend (293)            | ●    |      |      | ●    |  |
|              |                               |      |      |      |      |  |
| INFINITI     | Aged Bronze Enhanced (558)    |      |      | ●    |      |  |
|              | Chestnut Brown Enhanced (556) |      |      | ●    |      |  |
|              | Granite Gray Enhanced (557)   |      |      | ●    |      |  |
|              | Obsidian (599)                |      |      | ●    |      |  |
|              | Weathered Wood Enhanced (555) |      |      | ●    |      |  |
|              |                               |      |      |      |      |  |
| GENERATIONS  | Cedar HD (281)                |      | ●    |      |      |  |
|              | Charcoal Gray HD (278)        |      | ●    |      |      |  |
|              | Classic Red HD (277)          |      | ●    |      |      |  |
|              | Copper HD (280)               |      | ●    |      |      |  |
|              | Hartford Green HD (266)       |      | ●    |      |      |  |
|              | Royal Brown HD (263)          |      | ●    |      |      |  |
|              | T-Tone HD (268)               |      | ●    |      |      |  |

# ARROWLINE

## ROOFING ACCESSORIES

### PRODUCT CODE

#### OPEN VALLEY STARTER

1728-000

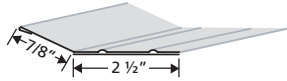

Length: 10'  
 Thickness: 28 Ga.  
 Pieces/Ctn: 10  
 lbs/Ctn: 27

Use with Valley Flashing #1727-\_\_\_\_. Need 2 pieces of starter for 1 piece of Valley Flashing.

#### LT2000 ROLL OVER TOOL

3751-000

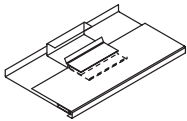

#### FOAM SEAL

3734-000

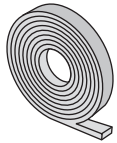

Length: 20'  
 Pieces/Ctn: 1  
 lbs/Ctn: 1

5/8" X 1-3/16".

#### SOLAR MOUNTING NEW CONSTRUCTION BRACKET

3754-000



lbs: 1  
 Pieces/Ctn: 50  
 lbs/Ctn: 46

Includes fasteners.

#### SOLAR MOUNTING RETROFIT BRACKET

3755-000



lbs: 1.2  
 Pieces/Ctn: 36  
 lbs/Ctn: 42

Includes fasteners.

# ARROWLINE

## ROOFING UNDERLAYMENT ▶▶▶

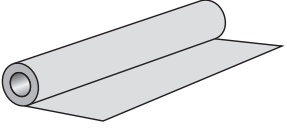
|   | PRODUCT CODE  |                 |
|---|---------------|-----------------|
| <b>TITANIUM UNDERLAYMENT</b>  | <b>PSU 30</b> | <b>3724-000</b> |
|   | Width:        | 36"             |
|   | Length:       | 72'             |
|   | Sq.Ft/Roll:   | 216             |
|   | lbs/Roll:     | 48              |
|  | <b>UDL 30</b> | <b>3722-000</b> |
|   | lbs/Roll:     | 40              |
|   | <b>UDL 50</b> | <b>3723-000</b> |
|   | lbs/Roll:     | 48              |
|   | Width:        | 48"             |
|   | Length:       | 250'            |
|   | Sq.Ft/Roll:   | 1,000           |

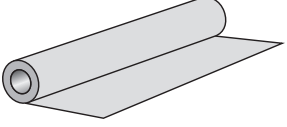
|   |            |                 |
|---|------------|-----------------|
| <b>MfM WIND &amp; WATER SEAL</b>  | <b>6"</b>  | <b>3726-000</b> |
|   | Length:    | 67'             |
|   | lbs/Roll:  | 10              |
|   | Rolls/Ctn: | 6               |
|  | <b>2"</b>  | <b>3727-000</b> |
|   | Length:    | 75'             |
|   | lbs/Roll:  | 3               |
|   | Rolls/Ctn: | 18              |

# ARROWLINE

## ROOFING ACCESSORIES



**PRODUCT CODE**

---

**SNO GEM® SNOW RETENTION PENNANT** **1765-\_\_**

Thickness: 28 Ga.  
 Pieces/Ctn: 100  
 lbs/Ctn: 23

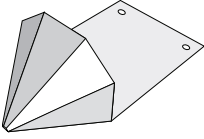

2 pieces.

---

**TOUCH-UP PENS** **3400-\_\_**

Pen (oz): 0.3  
 Pen/Ctn: 12





---

| Product Code          | 1765 | 3400 |  |
|-----------------------|------|------|--|
| Aged Bronze (537)     | ●    | ●    |  |
| Black- Obsidian (511) | ●    | ●    |  |
| Cedar (261)           | ●    | ●    |  |
| Charcoal Gray (228)   | ●    | ●    |  |
| Chestnut Brown (539)  | ●    | ●    |  |
| Classic Blue (207)    | ●    | ●    |  |
| Classic Red (227)     | ●    | ●    |  |
| Copper (260)          | ●    | ●    |  |
| Granite Gray (538)    | ●    | ●    |  |
| Hartford Green (206)  | ●    | ●    |  |
| Pewter (216)          | ●    | ●    |  |
| Royal Brown (203)     | ●    | ●    |  |
| Sandtone (212)        | ●    | ●    |  |
| Statuary Bronze (213) | ●    | ●    |  |
| Stone (257)           | ●    | ●    |  |
| T-Tone (208)          | ●    | ●    |  |
| Weathered Wood (540)  | ●    | ●    |  |

PVDF SOLID

# ARROWLINE

## SCREWS, NAILS & TOOLS

|   | PRODUCT CODE    |                 |
|---|-----------------|-----------------|
| <b>NEW SECUREFAST ROOFING,<br/>#10 SCREW</b>                                      | <b>1"</b>       | <b>3544-000</b> |
|   | Pcs/Ctn:        | 5000            |
|   | StickTight Bits | 2               |
|  | <b>1-1/2"</b>   | <b>3545-000</b> |
|   | Pcs/Ctn:        | 4000            |
|   | StickTight Bits | 2               |
|   | <b>2"</b>       | <b>3546-000</b> |
|   | Pcs/Ctn:        | 3000            |
|   | StickTight Bits | 1               |

|   |                 |
|---|-----------------|
| <b>NEW SECUREFAST ROOFING<br/>STICK-TIGHT BIT</b> | <b>3549-000</b> |
|---|-----------------|



|   |               |                 |
|---|---------------|-----------------|
| <b>#10 MILL FINISH ZINC-PLATED<br/>ZIP SCREW</b>                                    | <b>1"</b>     | <b>3283-000</b> |
|   | Pieces/Jar:   | 500             |
|   | Qty/Ctn:      | 8000            |
|   | lbs/Ctn:      | 24              |
|   | Jars/Ctn:     | 16              |
|  | <b>1-1/2"</b> | <b>3284-000</b> |
|   | Pieces/Jar:   | 250             |
|   | Qty/Ctn:      | 8000            |
|   | lbs/Ctn:      | 24              |
|   | Jars/Ctn:     | 16              |
|   | <b>2"</b>     | <b>3285-000</b> |
|   | Pieces/Jar:   | 250             |
|   | Qty/Ctn:      | 8000            |
|   | lbs/Ctn:      | 24              |
|   | Jars/Ctn:     | 16              |

|   | PRODUCT CODE  |                 |
|---|---------------|-----------------|
| <b>TRUSS TORX HEAD<br/>SCREW</b>  | <b>1"</b>     | <b>3287-000</b> |
|   | Pieces/Ctn:   | 500             |
|   | lbs/Ctn:      | 3               |
|  | <b>1-1/2"</b> | <b>3288-000</b> |
|   | Pieces/Ctn:   | 250             |
|   | lbs/Ctn:      | 2               |

|  | PRODUCT CODE            |                 |
|--|-------------------------|-----------------|
| <b>LEFT, RIGHT, OFFSET &amp;<br/>COMBINATION CREWLINE<br/>AVIATION SNIPS</b> | <b>Left AV1 Cut</b>     | <b>3127-000</b> |
|  | <b>Right AV2 Cut</b>    | <b>3128-000</b> |
|  | <b>Combo AV3 Cut</b>    | <b>3129-000</b> |
|  | <b>Left AV6 Offset</b>  | <b>3130-000</b> |
|  | <b>Right AV7 Offset</b> | <b>3131-000</b> |



|                                 |            |                 |
|---------------------------------|------------|-----------------|
| <b>MALCO HAND SEAMER<br/>6"</b> | <b>S6R</b> | <b>3142-000</b> |
|---------------------------------|------------|-----------------|



|  |            |                 |
|--|------------|-----------------|
| <b>MALCO HAND SEAMER<br/>OFFSET 3"</b> | <b>S3R</b> | <b>3143-000</b> |
|--|------------|-----------------|



|                            | PRODUCT CODE      |                 |
|----------------------------|-------------------|-----------------|
| <b>TENRYU STEEL BLADES</b> | <b>5-3/8" 56t</b> | <b>3057-000</b> |
|                            | <b>Plus X</b>     |                 |
|                            | <b>6-1/2" 64t</b> | <b>3056-000</b> |
|                            | <b>Plus X</b>     |                 |
|                            | <b>7-1/4" 72t</b> | <b>3058-000</b> |
|                            | <b>Plus X</b>     |                 |
|                            | <b>7-1/4" 48t</b> | <b>3050-000</b> |
|                            | <b>Pro</b>        |                 |
|                            | <b>10" 50t</b>    | <b>3054-000</b> |
|                            | <b>Pro</b>        |                 |
| <b>12" 60t</b>             | <b>3055-000</b>   |                 |
| <b>Pro</b>                 |                   |                 |



For ferrous metal only.

# ARROWLINE

## ROOFING ESTIMATION GUIDE



|   |              |                        |                    |
|---|--------------|------------------------|--------------------|
| <b>FIELD AREA</b>   |              |                        |                    |
| TOTAL SQ FT + 15% (+/-) FOR WASTE   |              | TOTAL SQ FT: _____     |                    |
| 1/2 SQUARE CARTONS  |              | CARTONS: _____         |                    |
| <b>SHAKE</b>  | <b>SLATE</b> | <b>INFINITI</b>        | <b>GENERATIONS</b> |
| COLOR: _____  |              |                        |                    |
| Calculate total area as normal, factor in an additional 15% for waste. With excessive Hip and Valley, it may be necessary to increase waste percentage to as much as 17%. If you are calculating a material list from a blueprint, it is necessary to factor the roof pitch. NOTE: Minimum pitch requirement is 4/12.   |              |                        |                    |
| 4/12 = 1.054  | 7/12 = 1.158 | 10/12 = 1.302          |                    |
| 5/12 = 1.083  | 8/12 = 1.202 | 12/12 = 1.414          |                    |
| 6/12 = 1.118  | 9/12 = 1.250 |                        |                    |
| <b>HIP/RIDGE ASSEMBLY:</b> Calculate total linear footage. Add 5%, and divide by 10 for number of pieces. Vented Ridge will require three components: Trimline Venting, Ridge Starter Base and Hip/Ridge Caps. Fasten with 2" Hex Head screws. Non-Vented Ridge/Hips require two components: Starter Base with Foam and Hip/Ridge Caps. Fasten with 1-1/2" Hex Head screws. |              |                        |                    |
| <b>RIDGE ASSEMBLY</b><br>10' LENGTHS, 5 PCS/CTN   |              |                        |                    |
| <b>RIDGE STARTER BASE (WITHOUT FOAM)</b>  | 1725-000     | QTY: _____             |                    |
| <b>TRIMLINE VENTING</b>   | 1733-000     | QTY: _____             |                    |
| TOTAL LINEAR FT: _____  |              |                        |                    |
| <b>HIP ASSEMBLY</b><br>10' LENGTHS, 5 PCS/CTN   |              |                        |                    |
| <b>STARTER BASE (WITH FOAM)</b>   | 1724-000     | QTY: _____             |                    |
| TOTAL LINEAR FT: _____  |              |                        |                    |
| <b>HIP &amp; RIDGE CAPS</b><br>1' PIECES, 20 PCS/CTN  |              |                        |                    |
| QTY: _____  |              | TOTAL LINEAR FT: _____ |                    |
| <b>RAKE STARTER</b><br>10' LENGTHS, 10 PCS/CTN,   |              |                        |                    |
| <b>28 GA.</b>   | 1722-        | QTY: _____             |                    |
| TOTAL LINEAR FT: _____  |              |                        |                    |
| <b>7/8" J-TRIM</b><br>10' LENGTHS, 10 PCS/CTN,  |              |                        |                    |
| <b>28 GA.</b>   | 1723-        | QTY: _____             |                    |
| TOTAL LINEAR FT: _____  |              |                        |                    |
| <b>UNDERLAYMENTS</b>  |              |                        |                    |
| <b>PSU ICE/WATER 36" X 72"</b>  | 3724-000     | QTY: _____             |                    |
| <b>UDL 30-YEAR 48" X 250'</b>   | 3722-000     | QTY: _____             |                    |
| <b>UDL 50-YEAR 48" X 250'</b>   | 3723-000     | QTY: _____             |                    |

|  |           |            |  |
|--|-----------|------------|--|
| <b>EAVE STARTER</b><br>10' LENGTHS, 10 PCS/CTN   |           |            |  |
| <b>28 GA.</b>  | 1721-     | QTY: _____ |  |
| TOTAL LINEAR FT: _____   |           |            |  |
| <b>ROLL-OVER:</b> Calculate entire perimeter of roof area, add 5%, and divide by 10 for number of pieces. No Rake starter & J-Channel will be used.  |           |            |  |
| <b>RAKE STARTER &amp; J-CHANNEL:</b> Calculate total linear footage of gable roof edge, add 5% and divide by 10 for number of pieces. Always use equal number of pieces of Rake Starter and J-Channel. (NOTE: This application requires the combination use of Eave Starter, Rake Starter and J-Channel.)  |           |            |  |
| <b>VALLEY ASSEMBLY</b> Calculate the total linear footage of valley and divide by 10 for number of pieces. Consider overlap and overhang in your measurements. Open Valley requires 2 pcs Valley Starter Strip per Valley Flashing. Measure length of valley and divide by 10'. Add enough waste for cuts and laps. Closed Valley requires three components: Valley Flashing, Valley Cap, and Filter Foam. Measure length of valley and divide by 10'. Add enough waste for cuts and laps. |           |            |  |
| <b>CLOSED VALLEY ASSEMBLY</b>  |           |            |  |
| <b>VALLEY CAP</b><br>10' LENGTHS, 5 PCS/CTN  | 1734-     | QTY: _____ |  |
| <b>FILTER FOAM</b><br>6'-6" LENGTHS, 30 PCS/CTN  | 3725-000  | QTY: _____ |  |
| TOTAL LINEAR FT: _____   |           |            |  |
| <b>VALLEY FLASHING</b><br>10' LENGTHS, 5 PCS/CTN,  |           |            |  |
| <b>28 GA.</b>  | 1727-     | QTY: _____ |  |
| TOTAL LINEAR FT: _____   |           |            |  |
| <b>OPEN VALLEY STARTER</b><br>10' LENGTHS (NEED 2 PCS. VALLEY FLASHING), 10 PCS/CTN  |           |            |  |
| <b>28 GA.</b>  | 1728-000  | QTY: _____ |  |
| TOTAL LINEAR FT: _____   |           |            |  |
| <b>ENDWALL FLASHINGS</b><br>10' PIECES, 5 PCS/CTN  |           |            |  |
| <b>HEAD WALL</b>   | 1746-     | QTY: _____ |  |
| <b>SIDE WALL</b>   | 1747-     | QTY: _____ |  |
| TOTAL LINEAR FT: _____   |           |            |  |
| <b>SHINGLE CLIPS</b><br>FIGURE 120/SQUARE (50/BOX)   |           |            |  |
| <b>SHINGLE CLIP</b>  | 1731-000  | QTY: _____ |  |
| <b>VALLEY CLIP</b>   | 1732-000  | QTY: _____ |  |
| TOTAL LINEAR FT: _____   |           |            |  |
| <b>SCREWS</b>  |           |            |  |
| <b>SECUREFAST SCREWS</b>   | See P. 37 | QTY: _____ |  |
| TOTAL LINEAR FT: _____   |           |            |  |

# RAINWARE

## STEEL



**STEEL ELBOWS 2" x 3"** **PRODUCT CODE**

**Style A** 1290-\_\_\_

**Style B** 1291-\_\_\_

**Style 45° A** 1287-\_\_\_

Thickness: 28 Ga.  
 Pieces/Ctn: 30  
 lbs/Ctn: 18  
 Ctns/Skid: 30  
 lbs/Skid: 540

**STEEL ELBOWS 3" x 4"** **PRODUCT CODE**

**Style A** 1296-\_\_\_

**Style B** 1297-\_\_\_

**Style 45° A** 1298-\_\_\_

Thickness: 28 Ga.  
 Pieces/Ctn: 20  
 lbs/Ctn: 22  
 Ctns/Skid: 24  
 lbs/Skid: 528

**STEEL DOWNSPOUTS 2" x 3"** **1289-\_\_\_**

Length: 10'  
 Thickness: 28 Ga.  
 Pieces/Ctn: 10  
 lbs/Ctn: 64  
 Ctns/Skid: 32  
 lbs/Skid: 2,048

**STEEL DOWNSPOUTS 3" x 4"** **1295-\_\_\_**

Length: 10'  
 Thickness: 28 Ga.  
 Pieces/Ctn: 10  
 lbs/Ctn: 82  
 Ctns/Skid: 21  
 lbs/Skid: 1,722

| Product Code          | 1287,<br>1290,<br>1291 | 1289 | 1295 | 1296,<br>1297,<br>1298 |  |
|-----------------------|------------------------|------|------|------------------------|--|
| Polar White (001)     | ●                      | ●    | ●    | ●                      |  |
| Black (711)           | ●                      | ●    | ●    | ●                      |  |
| Canyon (786)          | ●                      | ●    | ●    | ●                      |  |
| Cedarwood (735)       | ●                      | ●    | ●    | ●                      |  |
| Charcoal Gray (728)   | ●                      | ●    | ●    | ●                      |  |
| Classic Blue (707)    | ●                      | ●    | ●    | ●                      |  |
| Classic Red (727)     | ●                      | ●    | ●    | ●                      |  |
| Claytone (709)        | ●                      | ●    | ●    | ●                      |  |
| Colonial White (720)  | ●                      | ●    | ●    | ●                      |  |
| Cool Atlantic (731)   | ●                      | ●    | ●    | ●                      |  |
| Deep Ocean (724)      |                        |      | ●    | ●                      |  |
| Desert Tone (718)     | ●                      | ●    | ●    | ●                      |  |
| Driftwood Gray (726)  | ●                      | ●    | ●    | ●                      |  |
| Glacier White (714)   | ●                      | ●    | ●    | ●                      |  |
| Hartford Green (706)  |                        |      | ●    | ●                      |  |
| Iron Gray (719)       |                        |      | ●    | ●                      |  |
| Mahogany (785)        | ●                      | ●    | ●    | ●                      |  |
| Midnight* (1111)      | ●                      | ●    | ●    | ●                      |  |
| Royal Brown (703)     |                        |      | ●    | ●                      |  |
| Rustic Brown (722)    | ●                      | ●    | ●    | ●                      |  |
| Sage (790)            | ●                      | ●    | ●    | ●                      |  |
| Sand Beige (721)      | ●                      | ●    | ●    | ●                      |  |
| Sandtone (712)        | ●                      | ●    | ●    | ●                      |  |
| Statuary Bronze (713) |                        |      | ●    | ●                      |  |
| Still Harbor (738)    | ●                      | ●    | ●    | ●                      |  |
| Timber (736)          | ●                      | ●    | ●    | ●                      |  |
| T-Tone (708)          | ●                      | ●    | ●    | ●                      |  |
| Wickertone (717)      | ●                      | ●    | ●    | ●                      |  |
| Willow (792)          | ●                      | ●    | ●    | ●                      |  |

\*Midnight is SMP (ENTEX® without the texture).

# RAINWARE

## ALUMINUM



**PRODUCT CODE**

**ALUMINUM ELBOWS 2" x 3"**      **Style A**    **1258-\_\_**

**Style B**    **1259-\_\_**

**Style 45° A**    **1262-\_\_**

Thickness: .019"

Pieces/Ctn: 30

lbs/Ctn: 8

Ctns/Skid: 32

lbs/Skid: 800

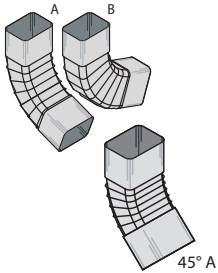

**ALUMINUM ELBOWS 3" x 4"**      **Style A**    **1246-\_\_**

**Style B**    **1247-\_\_**

**Style 45° A**    **1248-\_\_**

Thickness: .019"

Pieces/Ctn: 20

lbs/Ctn: 9

Ctns/Skid: 24

lbs/Skid: 216

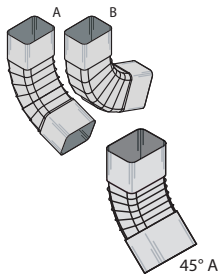

**ALUMINUM DOWNSPOUTS**      **1257-\_\_**

**2" x 3"**

Length: 10'

Thickness: .019"

Pieces/Ctn: 10

lbs/Ctn: 25

Ctns/Skid: 32

lbs/Skid: 800

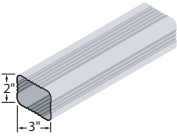

**ALUMINUM DOWNSPOUTS**      **1245-\_\_**

**3" x 4"**

Length: 10'

Thickness: .019"

Pieces/Ctn: 10

lbs/Ctn: 33

Ctns/Skid: 24

lbs/Skid: 600

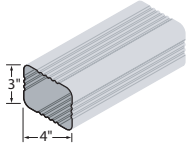



| Product Code            | 1245 | 1246, 1247, 1248 | 1257 | 1258, 1259, 1262 |  |
|-------------------------|------|------------------|------|------------------|--|
| Polar White (001)       | ●    | ●                | ●    | ●                |  |
| Almond Cream (702)      | ●    | ●                | ●    | ●                |  |
| Antique Parchment (715) | ●    | ●                | ●    | ●                |  |
| Black (711)             | ●    | ●                | ●    | ●                |  |
| Canyon (786)            | ●    | ●                |      |                  |  |
| Charcoal Gray (728)     | ●    | ●                | ●    | ●                |  |
| Claytone (709)          | ●    | ●                | ●    | ●                |  |
| Colonial White (720)    | ●    | ●                | ●    | ●                |  |
| Cool Atlantic (731)     | ●    | ●                | ●    | ●                |  |
| Deep Ocean (724)        | ●    | ●                |      |                  |  |
| Desert Tone (718)       | ●    | ●                | ●    | ●                |  |
| Driftwood Gray (726)    | ●    | ●                | ●    | ●                |  |
| Glacier White (714)     | ●    | ●                | ●    | ●                |  |
| Hartford Green (706)    | ●    | ●                |      |                  |  |
| Heritage Gray (710)     | ●    | ●                |      |                  |  |
| Iron Gray (719)         | ●    | ●                | ●    | ●                |  |
| Midnight* (1111)        | ●    | ●                | ●    | ●                |  |
| Royal Brown (703)       | ●    | ●                | ●    | ●                |  |
| Rustic Brown (722)      | ●    | ●                | ●    | ●                |  |
| Sand Beige (721)        | ●    | ●                | ●    | ●                |  |
| Sandtone (712)          | ●    | ●                | ●    | ●                |  |
| Statuary Bronze (713)   | ●    | ●                | ●    | ●                |  |
| Still Harbor (738)      | ●    | ●                | ●    | ●                |  |
| Timber (736)            | ●    | ●                |      |                  |  |
| T-Tone (708)            | ●    | ●                | ●    | ●                |  |
| Wickertone (717)        | ●    | ●                | ●    | ●                |  |

\*Midnight is SMP (ENTEX® without the texture).

# RAINWARE

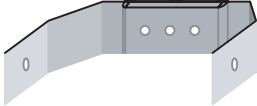
## ACCESSORIES

|   | PRODUCT CODE     |                 |
|---|------------------|-----------------|
| <b>ALUMINUM DOWNSPOUT U-BAND</b>  | <b>2" x 3"</b>   | <b>1263-___</b> |
|   | <b>3" x 4"</b>   | <b>1264-___</b> |
|  | Thickness: .032" |                 |
|   | Pieces/Ctn: 100  |                 |
|   | lbs/Ctn: 3       |                 |

|   | PRODUCT CODE     |  |
|---|------------------|--|
| <b>ALUMINUM DOWNSPOUT PIPE BAND</b>   | <b>1260-___</b>  |  |
|  | Thickness: .019" |  |
|   | Pieces/Ctn: 100  |  |
|   | lbs/Ctn: 4       |  |
|   | Ctns/Skid: 24    |  |
|   | lbs/Skid: 528    |  |

For use with 2" x 3" Downspouts & Elbows.

|   | PRODUCT CODE     |  |
|---|------------------|--|
| <b>ALUMINUM FORMED K-STYLE GUTTER</b>   | <b>1149-___</b>  |  |
|  | Length: 40' Max  |  |
|   | Thickness: .032" |  |

Maximum Delivery Length is 34'.

|   | PRODUCT CODE           |                 |
|---|------------------------|-----------------|
| <b>GUTTERWORKS HINGES</b>   | <b>3215-001</b>        |                 |
|  | <b>2" x 3" Style A</b> | <b>3216-001</b> |
|   | <b>2" x 3" Style B</b> | <b>3217-001</b> |
|   | <b>3" x 4" Style A</b> | <b>3218-001</b> |
|   | <b>3" x 4" Style B</b> |                 |

|   | PRODUCT CODE    |  |
|---|-----------------|--|
| <b>ZIP-HINGE DOWNSPOUT, WHITE (2 PAIR)</b>  | <b>3219-001</b> |  |
|  | Pieces/Ctn: 24  |  |
|   | lbs/Ctn: 8.16   |  |



Each bag is packed with white zip screws and downspout retainers.

| Product Code            | 1149 | 1260 | 1263 | 1264 |  |
|-------------------------|------|------|------|------|--|
| Polar White (001)       | ●    | ●    | ●    | ●    |  |
| Almond Cream (702)      | ●    |      | ●    | ●    |  |
| Antique Parchment (715) | ●    |      | ●    | ●    |  |
| Black (711)             | ●    |      | ●    | ●    |  |
| Canyon (786)            | ●    |      | ●    | ●    |  |
| Cedarwood (735)         | ●    |      | ●    | ●    |  |
| Charcoal Gray (728)     | ●    |      | ●    | ●    |  |
| Classic Blue (707)      | ●    |      | ●    | ●    |  |
| Classic Red (727)       | ●    |      | ●    | ●    |  |
| Claytone (709)          | ●    |      | ●    | ●    |  |
| Colonial White (720)    | ●    |      | ●    | ●    |  |
| Deep Ocean (724)        | ●    |      |      | ●    |  |
| Desert Tone (718)       | ●    |      | ●    | ●    |  |
| Driftwood Gray (726)    | ●    |      | ●    | ●    |  |
| Glacier White (714)     | ●    | ●    | ●    | ●    |  |
| Hartford Green (706)    | ●    |      |      | ●    |  |
| Iron Gray (719)         | ●    |      | ●    | ●    |  |
| Midnight (1111)         | ●    |      | ●    | ●    |  |
| Mahogany (785)          | ●    |      | ●    | ●    |  |
| Royal Brown (703)       | ●    |      | ●    | ●    |  |
| Rustic Brown (722)      | ●    |      | ●    | ●    |  |
| Sage (790)              | ●    |      | ●    | ●    |  |
| Sand Beige (721)        | ●    |      | ●    | ●    |  |
| Sandtone (712)          | ●    |      | ●    | ●    |  |
| Statuary Bronze (713)   | ●    |      | ●    | ●    |  |
| Timber (736)            | ●    |      | ●    | ●    |  |
| T-Tone (708)            | ●    |      | ●    | ●    |  |
| Wickertone (717)        | ●    |      | ●    | ●    |  |
| Willow (792)            | ●    |      | ●    | ●    |  |

\*Midnight is SMP (ENTEX® without the texture).

# RAINWARE

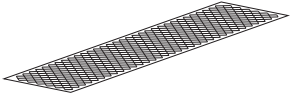
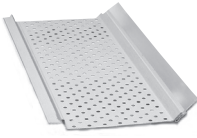
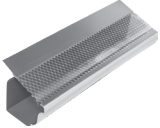
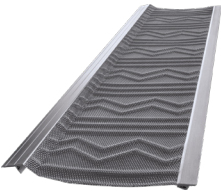
## ACCESSORIES

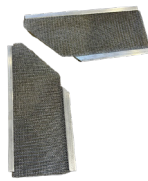
|   | PRODUCT CODE             |   | PRODUCT CODE   |
|---|--------------------------|---|--|
| <b>6" E-Z DROP GUTTER GUARD ALUMINUM</b><br>             | <b>3220-000</b>          | Length: 4'  | <b>BLACK GALVANIZED GUTTER GUARD</b><br><b>5" 3222-011</b><br>lbs/Ctn: 22<br><b>6" 3221-011</b><br>lbs/Ctn: 26<br>Length: 4'<br>Pieces/Ctn: 25 |
|   |                          | Pieces/Ctn: 25<br>lbs/Ctn: 20                                 |  |
| <b>5" LEAF RELIEF BY PLYGEM</b><br>                      | <b>Retrofit 3265-000</b> | Pieces/Ctn: 32<br>Length: 10'                                 | <b>EXTREME 5" GUTTER GUARD FASCIA MOUNT MITERS</b><br><b>OS Miter 3234-001</b><br><b>IS Miter 3235-001</b><br>Pieces/Ctn: 5                    |
|   |                          | Pieces/Ctn: 20  |  |
| <b>EXTREME GUTTER GUARD</b><br>                         | <b>Flatback 3232-000</b> | Pieces/Ctn: 20  | <b>EXTREME 5" GUTTER GUARD FLAT BACK MITERS</b><br><b>IS Miter 3237-001</b><br>Pieces/Ctn: 5   |
|   |                          | lbs/Piece: 1<br>lbs/Ctn: 20                                   |  |
| 5" x 5' Mill.   | <b>Fascia 3233-000</b>   |   |  |
| <b>MICRO-MESH 30 STAINLESS STEEL GUTTER SCREEN</b><br> | <b>3225-000</b>          | Length: 4'<br>Pieces/Ctn: 25<br>lbs/Piece: 1<br>lbs/Ctn: 25   | <b>E-Z SMOOTH FLOW GUTTER GUARD</b><br>                    |
|   | 5" x 4'.                 |   |  |
| <b>MICRO-MESH 8 INSIDE MITER</b><br>                   | <b>3223-000</b>          | Length: 20"<br>Pieces/Ctn: 10<br>lbs/Piece: 0.5<br>lbs/Ctn: 5 |  |
|   | 5" x 20".                |   |  |

# RAINWARE

## ACCESSORIES

|   | <b>PRODUCT CODE</b> |
|---|---------------------|
| <b>ALUMINUM SLIP JOINT GUTTER CONNECTOR</b> | <b>3201-001</b>     |
| Thickness: .019"                            |                     |
| Pieces/Ctn: 50                              |                     |
| Lbs/Ctn: 5                                  |                     |

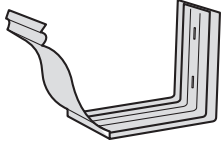

|                          | <b>5" Right</b> | <b>1266-__</b> |
|--------------------------|-----------------|----------------|
| <b>ALUMINUM END CAPS</b> |                 |                |
|                          | <b>5" Left</b>  | <b>1265-__</b> |
|                          | <b>6" Right</b> | <b>1271-__</b> |
|                          | <b>6" Left</b>  | <b>1270-__</b> |
| Thickness: .019"         |                 |                |
| Pieces/Ctn: 50           |                 |                |
| Lbs/Ctn: 3               |                 |                |

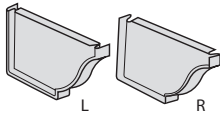

|                                   | <b>1252-__</b> |
|-----------------------------------|----------------|
| <b>ALUMINUM OUTSIDE BOX MITER</b> |                |
| Thickness: .019"                  |                |
| Pieces/Ctn: 20                    |                |
| Lbs/Ctn: 7                        |                |

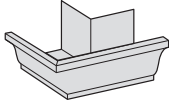

|                                  | <b>1253-__</b> |
|----------------------------------|----------------|
| <b>ALUMINUM INSIDE BOX MITER</b> |                |
| Length: .019"                    |                |
| Pieces/Ctn: 20                   |                |
| Lbs/Ctn: 7                       |                |

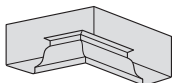

|                  | <b>Product Code</b>     | <b>1252,<br/>1253</b> | <b>1265,<br/>1266</b> | <b>1270,<br/>1271</b> |  |
|------------------|-------------------------|-----------------------|-----------------------|-----------------------|--|
|                  | Polar White (001)       | ●                     | ●                     | ●                     |  |
| <b>ENTEX®</b>    | Almond Cream (702)      | ●                     | ●                     | ●                     |  |
|                  | Antique Parchment (715) | ●                     | ●                     | ●                     |  |
|                  | Black (711)             | ●                     | ●                     | ●                     |  |
|                  | Canyon (786)            |                       | ●                     |                       |  |
|                  | Cedarwood (735)         |                       | ●                     | ●                     |  |
|                  | Charcoal Gray (728)     |                       | ●                     | ●                     |  |
|                  | Classic Blue (707)      |                       | ●                     |                       |  |
|                  | Classic Red (727)       |                       | ●                     |                       |  |
|                  | Claytone (709)          | ●                     | ●                     | ●                     |  |
|                  | Colonial White (720)    | ●                     | ●                     | ●                     |  |
|                  | Deep Ocean (724)        | ●                     | ●                     | ●                     |  |
|                  | Desert Tone (718)       | ●                     | ●                     | ●                     |  |
|                  | Driftwood Gray (726)    |                       | ●                     | ●                     |  |
|                  | Glacier White (714)     | ●                     | ●                     | ●                     |  |
|                  | Hartford Green (706)    | ●                     | ●                     | ●                     |  |
|                  | Iron Gray (719)         | ●                     | ●                     | ●                     |  |
|                  | Mahogany (785)          |                       | ●                     |                       |  |
|                  | Midnight* (1111)        | ●                     | ●                     | ●                     |  |
|                  | Royal Brown (703)       | ●                     | ●                     | ●                     |  |
|                  | Rustic Brown (722)      |                       | ●                     | ●                     |  |
|                  | Sage (790)              |                       | ●                     |                       |  |
|                  | Sand Beige (721)        | ●                     | ●                     |                       |  |
|                  | Sandtone (712)          | ●                     | ●                     | ●                     |  |
|                  | Statuary Bronze (713)   | ●                     | ●                     | ●                     |  |
|                  | Timber (736)            |                       | ●                     | ●                     |  |
|                  | T-Tone (708)            | ●                     | ●                     | ●                     |  |
| Wickertone (717) | ●                       | ●                     | ●                     |                       |  |
| Willow (792)     |                         | ●                     |                       |                       |  |

\*Midnight is SMP (ENTEX® without the texture).

# RAINWARE

## ACCESSORIES



|  |                    | PRODUCT CODE    |
|--|--------------------|-----------------|
| <b>5" OUTSIDE STRIP MITER ALUMINUM</b> | <b>90° Outside</b> | <b>1255-___</b> |
|  | <b>45° Outside</b> | <b>3250-001</b> |
| Thickness: .032"                       |                    |                 |
| Pieces/Ctn: 20                         |                    |                 |
| lbs/Ctn: 3                             |                    |                 |

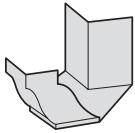

|                                       |                   |                 |
|---------------------------------------|-------------------|-----------------|
| <b>5" INSIDE STRIP MITER ALUMINUM</b> | <b>90° Inside</b> | <b>1256-___</b> |
|                                       | <b>45° Inside</b> | <b>3251-001</b> |
| Thickness: .032"                      |                   |                 |
| Pieces/Ctn: 20                        |                   |                 |
| lbs/Ctn: 3                            |                   |                 |

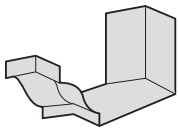

|  |                    |                 |
|--|--------------------|-----------------|
| <b>6" OUTSIDE STRIP MITER ALUMINUM</b> | <b>90° Outside</b> | <b>1272-___</b> |
|  | <b>45° Outside</b> | <b>3238-001</b> |
| Thickness: .032"                       |                    |                 |
| Pieces/Ctn: 20                         |                    |                 |
| lbs/Ctn: 3                             |                    |                 |

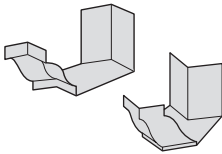

|                                       |                   |                 |
|---------------------------------------|-------------------|-----------------|
| <b>6" INSIDE STRIP MITER ALUMINUM</b> | <b>90° Inside</b> | <b>1273-___</b> |
|                                       | <b>45° Inside</b> | <b>3239-001</b> |
| Thickness: .032"                      |                   |                 |
| Pieces/Ctn: 20                        |                   |                 |
| lbs/Ctn: 3                            |                   |                 |

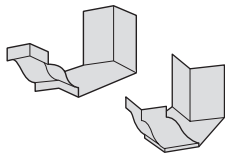

|                              |                 |
|------------------------------|-----------------|
| <b>GUTTER APRON ALUMINUM</b> | <b>1267-___</b> |
| Thickness: .019"             |                 |
| Length: 10'                  |                 |
| Pieces/Ctn: 25               |                 |
| lbs/Ctn: 26                  |                 |

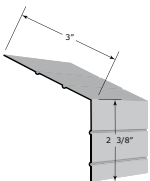

| Product Code            | 1255, 1256 | 1267 | 1272, 1273 |  |
|-------------------------|------------|------|------------|--|
| Polar White (001)       | ●          | ●    | ●          |  |
| Almond Cream (702)      | ●          | ●    | ●          |  |
| Antique Parchment (715) | ●          | ●    | ●          |  |
| Black (711)             | ●          | ●    | ●          |  |
| Canyon (786)            | ●          | ●    | ●          |  |
| Cedarwood (735)         | ●          | ●    | ●          |  |
| Charcoal Gray (728)     | ●          | ●    | ●          |  |
| Classic Blue (707)      | ●          | ●    | ●          |  |
| Classic Red (727)       | ●          | ●    | ●          |  |
| Claytone (709)          | ●          | ●    | ●          |  |
| Colonial White (720)    | ●          | ●    | ●          |  |
| Deep Ocean (724)        | ●          | ●    | ●          |  |
| Desert Tone (718)       | ●          | ●    | ●          |  |
| Driftwood Gray (726)    | ●          | ●    | ●          |  |
| Glacier White (714)     | ●          | ●    | ●          |  |
| Hartford Green (706)    | ●          | ●    | ●          |  |
| Iron Gray (719)         | ●          | ●    | ●          |  |
| Mahogany (785)          | ●          | ●    | ●          |  |
| Royal Brown (703)       | ●          | ●    | ●          |  |
| Rustic Brown (722)      | ●          | ●    | ●          |  |
| Sage (790)              | ●          | ●    | ●          |  |
| Sand Beige (721)        | ●          | ●    | ●          |  |
| Sandtone (712)          | ●          | ●    | ●          |  |
| Statuary Bronze (713)   | ●          | ●    | ●          |  |
| Timber (736)            | ●          | ●    | ●          |  |
| T-Tone (708)            | ●          | ●    | ●          |  |
| Wickertone (717)        | ●          | ●    | ●          |  |
| Willow (792)            | ●          | ●    | ●          |  |

ENTEX®

# RAINWARE

## ACCESSORIES

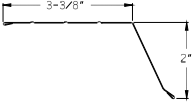
|   |                            | PRODUCT CODE          |            |
|---|----------------------------|-----------------------|------------|
|  | <b>HEMMED GUTTER APRON</b> | <b>Steel 1269-</b>    | <b>---</b> |
|   |                            | Thickness: 30 Ga.     |            |
|   |                            | lbs/Ctn: 58           |            |
|   |                            | <b>Aluminum 1277-</b> | <b>---</b> |
|   |                            | Thickness: .019"      |            |
|   |                            | lbs/Ctn: 25           |            |
|   |                            | Length: 10'           |            |
|   |                            | Pieces/Ctn: 20        |            |

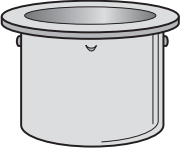
|   |  |                        |  |
|---|--|------------------------|--|
|  | <b>DROP OUTLET TUBE, ROUND, ALUMINUM</b> | <b>2-3/8" 3245-000</b> |  |
|   |  | lbs/Ctn: 11            |  |
|   |  | <b>2-3/4" 3247-000</b> |  |
|   |  | Thickness: .019"       |  |
|   |  | Pieces/Ctn: 250        |  |
|   |  | lbs/Ctn: 12            |  |

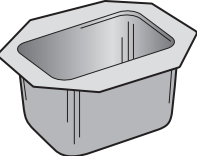
|   |  |                         |  |
|---|--|-------------------------|--|
|  | <b>DROP OUTLET TUBE, RECTANGLE, ALUMINUM</b> | <b>2" x 3" 3246-000</b> |  |
|   |  | Pieces/Ctn: 200         |  |
|   |  | <b>3" x 4" 3248-000</b> |  |
|   |  | Thickness: .019"        |  |
|   |  | Pieces/Ctn: 50          |  |
|   |  | lbs/Ctn: 6              |  |

| Product Code            | 1269 | 1277 |  |
|-------------------------|------|------|--|
| Polar White (001)       | ●    | ●    |  |
| Almond Cream (702)      |      | ●    |  |
| Antique Parchment (715) |      | ●    |  |
| Black (711)             | ●    | ●    |  |
| Canyon (786)            |      | ●    |  |
| Charcoal Gray (728)     | ●    | ●    |  |
| Claytone (709)          |      | ●    |  |
| Desert Tone (718)       |      | ●    |  |
| Hartford Green (706)    |      | ●    |  |
| Iron Gray (719)         | ●    | ●    |  |
| Royal Brown (703)       | ●    | ●    |  |
| Rustic Brown (722)      |      | ●    |  |
| Sandtone (712)          | ●    | ●    |  |
| Statuary Bronze (713)   | ●    | ●    |  |
| T-Tone (708)            | ●    | ●    |  |
| Wickertone (717)        |      | ●    |  |

# GUTTER COIL

## RAINWARE ACCESSORIES



**11-7/8" GUTTER COIL & ROLL OFF, ALUMINUM** **PRODUCT CODE**  
**1284-\_\_\_**

Width: 11-7/8"  
 Thickness: .032"  
 Ft/lb: 2.25  
 lbs/Roll: 300-400

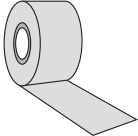

**15" GUTTER COIL & ROLL OFF, ALUMINUM** **PRODUCT CODE**  
**1283-\_\_\_**

Width: 15"  
 Thickness: .032"  
 Ft/lb: 1.8  
 lbs/Roll: 300-400

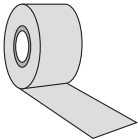

**13-1/4" GUTTER COIL & ROLL OFF, ALUMINUM** **PRODUCT CODE**  
**1531-\_\_\_**

Width: 13.25"  
 Thickness: .027"  
 Ft/lb: 2.39  
 lbs/Roll: 300-400

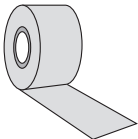



| Product Code            | 1283 | 1284 | 1531 |  |
|-------------------------|------|------|------|--|
| Polar White (001)       | ●    | ●    | ●    |  |
| Almond Cream (702)      | ●    | ●    | ●    |  |
| Antique Parchment (715) | ●    | ●    |      |  |
| Black (711)             | ●    | ●    | ●    |  |
| Canyon (786)            |      | ●    |      |  |
| Cedarwood (735)         |      | ●    |      |  |
| Charcoal Gray (728)     | ●    | ●    | ●    |  |
| Classic Blue (707)      |      | ●    |      |  |
| Classic Red (727)       |      | ●    |      |  |
| Claytone (709)          | ●    | ●    | ●    |  |
| Colonial White (720)    | ●    | ●    |      |  |
| Deep Ocean (724)        | ●    | ●    |      |  |
| Desert Tone (718)       | ●    | ●    |      |  |
| Driftwood Gray (726)    | ●    | ●    |      |  |
| Glacier White (714)     | ●    | ●    | ●    |  |
| Hartford Green (706)    | ●    | ●    |      |  |
| Iron Gray (719)         | ●    | ●    |      |  |
| Mahogany (785)          |      | ●    |      |  |
| Midnight* (1111)        | ●    | ●    |      |  |
| Royal Brown (703)       | ●    | ●    | ●    |  |
| Rustic Brown (722)      | ●    | ●    | ●    |  |
| Sage (790)              |      | ●    |      |  |
| Sand Beige (721)        |      | ●    |      |  |
| Sandtone (712)          | ●    | ●    | ●    |  |
| Statuary Bronze (713)   | ●    | ●    | ●    |  |
| Timber (736)            |      | ●    |      |  |
| T-Tone (708)            | ●    | ●    | ●    |  |
| Wickertone (717)        | ●    | ●    |      |  |
| Willow (792)            |      | ●    |      |  |

\*Midnight is SMP (ENTEX® without the texture).

# SCREWS/NAILS

## RAINWARE ACCESSORIES

|   | PRODUCT CODE                 |
|---|------------------------------|
| <b>GUTTER HANGER<br/>ZINC-PLATED SCREWS</b>                                       | <b>#10 x 1-1/2" 3286-000</b> |
|  | Pieces/Jar: 250              |
|   | Jars/Ctn: 16                 |
|   | lbs/Ctn: 48                  |

|   | PRODUCT CODE              |
|---|---------------------------|
| <b>PAINTED ZIP SCREWS</b>   | <b>#8 x 1/2" 3280-___</b> |
|  | Pieces/Bag: 100           |
|   | Bags/Ctn: 100             |
|   | lbs/Ctn: 30               |

|   | PRODUCT CODE              |
|---|---------------------------|
| <b>1/2" ALUMINUM POP-RIVET</b>  | <b>#8 x 1/2" 3261-___</b> |
|  | Length: 1/2"              |
|   | Pieces/Pkg: 100           |
|   | lbs/Pkg: 1                |

|   | PRODUCT CODE         |
|---|----------------------|
| <b>#8 MILL FINISH ZINC-PLATED<br/>ZIP SCREW</b>                                     | <b>1/2" 3281-000</b> |
|  | <b>1" 3282-000</b>   |
|   | Pieces/Bag: 100      |
|   | Pieces/Jar: 500      |
|   | Jars/Ctn: 16         |
|   | lbs/Jar: 3           |

| Product Code            | 3261 | 3280 |  |
|-------------------------|------|------|--|
| Polar White (001)       | ●    | ●    |  |
| Almond Cream (702)      | ●    | ●    |  |
| Antique Parchment (715) |      | ●    |  |
| Black (711)             | ●    | ●    |  |
| Canyon (786)            |      | ●    |  |
| Cedarwood (735)         |      | ●    |  |
| Charcoal Gray (728)     |      | ●    |  |
| Classic Blue (707)      |      | ●    |  |
| Classic Red (727)       |      | ●    |  |
| Claytone (709)          |      | ●    |  |
| Colonial White (720)    |      | ●    |  |
| Cool Atlantic (731)     |      | ●    |  |
| Copper (260)            |      | ●    |  |
| Deep Ocean (724)        |      | ●    |  |
| Desert Tone (718)       |      | ●    |  |
| Driftwood Gray (726)    | ●    | ●    |  |
| Glacier White (714)     |      | ●    |  |
| Heritage Gray (010)     |      | ●    |  |
| Iron Gray (719)         |      | ●    |  |
| Mahogany (785)          |      | ●    |  |
| Pewter (216)            |      | ●    |  |
| Royal Brown (703)       | ●    | ●    |  |
| Sage (790)              |      | ●    |  |
| Sandtone (712)          | ●    | ●    |  |
| Sherwood Green (134)    |      | ●    |  |
| Statuary Bronze (713)   |      | ●    |  |
| Still Harbor (738)      |      | ●    |  |
| Stone (257)             |      | ●    |  |
| Timber (736)            |      | ●    |  |
| T-Tone (708)            | ●    | ●    |  |
| Wickertone (717)        |      | ●    |  |
| Willow (792)            |      | ●    |  |

# ADHESIVES/SEALANTS

## RAINWARE ACCESSORIES

|   | PRODUCT CODE  |
|---|---|
| <b>RUSCOE GUTTER MASTIC 12-1</b>  | <b>3242-000</b>                                     |
|  | Capacity: 1/10 gal<br>Pieces/Ctn: 24<br>lbs/Ctn: 30 |

Aluminum Fortified Adhesive. Winter Blend.

|   |  |
|---|--|
| <b>RUSCOE GUTTER PERMANENT SEALANT</b>  | <b>3240-000</b>                                |
|  | Capacity: 4 oz<br>Pieces/Ctn: 12<br>lbs/Ctn: 6 |

|   |  |
|---|--|
| <b>RUSCOE GUTTER MASTIC 12-3</b>  | <b>3249-000</b>                                  |
|  | Capacity: 10 oz<br>Pieces/Ctn: 24<br>lbs/Ctn: 30 |

Self-Leveling Sealant. Summer Blend.

|   |  |                 |
|---|--|-----------------|
| <b>GEOCEL 2300 TRIPOLYMER SEALANT</b>   | <b>Clear</b>                                     | <b>3390-000</b> |
|   | <b>White</b>                                     | <b>3390-001</b> |
|  | Capacity: 10 oz<br>Pieces/Ctn: 24<br>lbs/Ctn: 30 |                 |

Paintable, dries clear and will not crack.

|   |  |
|---|--|
| <b>GEOCEL 2320 ALUMINUM/GRAY</b>  | <b>3391-ALU</b>                                  |
|  | Capacity: 10 oz<br>Pieces/Ctn: 24<br>lbs/Ctn: 30 |

# RAINWARE

## ACCESSORIES

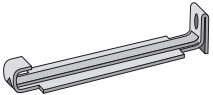
|   | PRODUCT CODE |                 |
|---|--------------|-----------------|
|  | <b>5"</b>    | <b>3294-000</b> |
|   | Pieces/Ctn:  | 500             |
|   | lbs/Ctn:     | 67              |
|   | <b>6"</b>    | <b>3295-000</b> |
|   | Pieces/Ctn:  | 500             |
|   | lbs/Ctn:     | 76              |

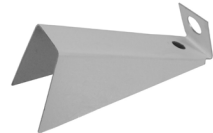
|  | PRODUCT CODE |                 |
|--|--------------|-----------------|
|  | <b>5"</b>    | <b>3202-001</b> |
|  | Pieces/Box:  | 100             |
|  | lbs/Box:     | 2.5             |

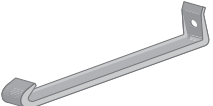
|   | PRODUCT CODE      |                 |
|---|-------------------|-----------------|
|  | <b>5" 100 ct</b>  | <b>3204-000</b> |
|   | <b>5" 1000 ct</b> | <b>3205-000</b> |
|   | <b>6" 100 ct</b>  | <b>3199-000</b> |
|   | <b>6" 1000 ct</b> | <b>3200-000</b> |

|  | PRODUCT CODE    |     |
|--|-----------------|-----|
|  | <b>3206-000</b> |     |
|  | Pieces/Ctn:     | 100 |
|  | lbs/Ctn:        | 8   |

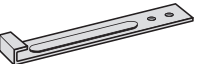
|   | PRODUCT CODE    |    |
|---|-----------------|----|
|  | <b>3212-000</b> |    |
|   | Pieces/Ctn:     | 50 |
|   | lbs/Ctn:        | 5  |

|   | PRODUCT CODE    |   |
|---|-----------------|---|
|  | <b>3270-000</b> |   |
|   | lbs/Ctn:        | 1 |

|   | PRODUCT CODE    |     |
|---|-----------------|-----|
|  | <b>3211-000</b> |     |
|   | Pieces/Ctn:     | 100 |
|   | lbs/Ctn:        | 8   |

|  | PRODUCT CODE |                 |
|--|--------------|-----------------|
|  | <b>5"</b>    | <b>3203-000</b> |
|  | Pieces/Ctn:  | 100             |
|  | lbs/Ctn:     | 8               |
| Aluminum. Comes with 3.5" screw.   |              |                 |

|   | PRODUCT CODE    |     |
|---|-----------------|-----|
|  | <b>3296-000</b> |     |
|   | Pieces/Ctn:     | 100 |
|   | lbs/Ctn:        | 3   |

|   | PRODUCT CODE                         |  |
|---|--------------------------------------|--|
|  | <b>3113-000</b>                      |  |
|   | Punches 5/32" x3/4" horizontal slot. |  |

# RAINWARE

## ACCESSORIES

|   |                     | PRODUCT CODE |
|---|---------------------|--------------|
|  | MALCO GUTTER PUNCH  |              |
|   | Tool Frame          | 3254-000     |
|   | 2" x 3" Rectangular | 3255-000     |
|   | 2" x 3" X-Style     | 3256-000     |
|   | 3" x 4" Rectangular | 3257-000     |
|   | 3" x 4" X-Style     | 3264-000     |

Use a ratcheting punch to knockout 2" x 3", 2" x 3" X-Out & 3" x 4".

|   |            |                 |          |
|---|------------|-----------------|----------|
|  | HEX DRIVER | 1/4" x 1-3/4"   | 3258-000 |
|   |            | 1/4" x 4"       | 3259-000 |
|   |            | 5/16" x 2-9/16" | 3275-000 |

|   |                          |              |          |
|---|--------------------------|--------------|----------|
|  | REVERSABLE 6" HEX DRIVER | 1/4" x 5/16" | 3155-000 |
|---|--------------------------|--------------|----------|

|  |   | PRODUCT CODE |
|--|---|--------------|
|  | LEFT, RIGHT, OFFSET & COMBINATION CREWLINE AVIATION SNIPS |              |
|  | Left AV1 Cut  | 3127-000     |
|  | Right AV2 Cut   | 3128-000     |
|  | Combo AV3 Cut   | 3129-000     |
|  | Left AV6 Offset   | 3130-000     |
|  | Right AV7 Offset  | 3131-000     |

|   |                      |     |          |
|---|----------------------|-----|----------|
|  | MALCO HAND SEAMER 6" | S6R | 3142-000 |
|---|----------------------|-----|----------|

|   |                             |     |          |
|---|-----------------------------|-----|----------|
|  | MALCO HAND SEAMER OFFSET 3" | S3R | 3143-000 |
|---|-----------------------------|-----|----------|

|   |                                |  |          |
|---|--------------------------------|--|----------|
|  | SL-2 SNAP LOCK (END CAP) PUNCH |  | 3110-000 |
|---|--------------------------------|--|----------|

Slide adjustment for throat depth allows setting from 1/4" to 5/8" depth.

# SOFFIT



## PLAIN QUAD SOFFIT ALUMINUM

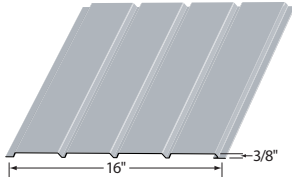

### PRODUCT CODE

1470-\_\_\_

Length: 12'  
 Thickness: .019"  
 Width: 16"  
 Pieces/Ctn: 12  
 Sq.Ft./Ctn: 192  
 lbs/Ctn: 58  
 Ctns/Skid: 30  
 lbs/Skid: 1,740

## CENTER-VENT QUAD SOFFIT ALUMINUM

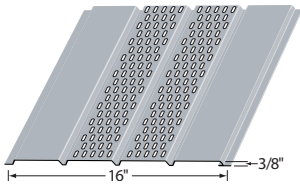

1474-\_\_\_

Length: 12'  
 Thickness: .019"  
 Width: 16"  
 Pieces/Ctn: 12  
 Sq.Ft./Ctn: 192  
 lbs/Ctn: 58  
 Ctns/Skid: 30  
 lbs/Skid: 1,740

## CENTER-VENT TRI SOFFIT ALUMINUM

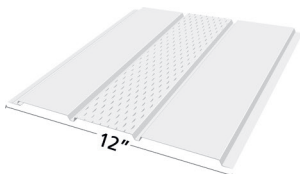

1484-\_\_\_

Length: 12'  
 Thickness: .019"  
 Width: 12"  
 Pieces/Ctn: 16  
 Sq.Ft./Ctn: 192  
 lbs/Ctn: 57  
 Ctns/Skid: 30  
 lbs/Skid: 1,710

## PLAIN TRI SOFFIT ALUMINUM

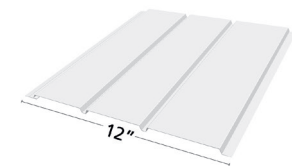

1480-\_\_\_

Length: 12'  
 Thickness: .019"  
 Width: 12"  
 Pieces/Ctn: 16  
 Sq.Ft./Ctn: 192  
 lbs/Ctn: 57  
 Ctns/Skid: 30  
 lbs/Skid: 1,710

| Product Code            | 1470 | 1474 | 1478 | 1480 | 1484 |
|-------------------------|------|------|------|------|------|
| Polar White (001)       | ●    | ●    | ●    | ●    | ●    |
| Almond Cream (702)      | ●    | ●    |      | ●    | ●    |
| Antique Parchment (715) | ●    | ●    |      | ●    | ●    |
| Black (711)             | ●    | ●    |      | ●    | ●    |
| Canyon (786)            | ●    | ●    |      | ●    | ●    |
| Cedarwood (735)         | ●    | ●    |      |      |      |
| Charcoal Gray (728)     | ●    | ●    |      | ●    | ●    |
| Classic Red (727)       | ●    | ●    |      |      |      |
| Claytone (709)          | ●    | ●    |      | ●    | ●    |
| Colonial White (720)    | ●    | ●    |      |      |      |
| Desert Tone (718)       | ●    | ●    |      | ●    | ●    |
| Driftwood Gray (726)    | ●    | ●    |      |      |      |
| Glacier White (714)     | ●    | ●    | ●    |      |      |
| Hartford Green (706)    | ●    | ●    |      | ●    | ●    |
| Iron Gray (719)         | ●    | ●    |      |      |      |
| Mahogany (785)          | ●    | ●    |      |      |      |
| Midnight* (1111)        | ●    | ●    |      |      |      |
| Royal Brown (703)       | ●    | ●    |      | ●    | ●    |
| Rustic Brown (722)      | ●    | ●    |      | ●    | ●    |
| Sand Beige (721)        | ●    | ●    |      |      |      |
| Sandtone (712)          | ●    | ●    |      | ●    | ●    |
| Stat Bronze (713)       | ●    | ●    |      | ●    | ●    |
| Timber (736)            | ●    | ●    |      |      |      |
| T-Tone (708)            | ●    | ●    |      | ●    | ●    |
| Wickertone (717)        | ●    | ●    |      | ●    | ●    |

\*Midnight is SMP (ENTEX® without the texture).

### PRODUCT CODE

## FULL-VENT QUAD SOFFIT ALUMINUM

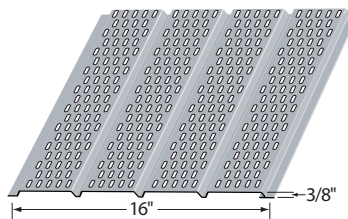

1478-\_\_\_

Length: 12'  
 Thickness: .019"  
 Width: 16"  
 Pieces/Ctn: 12  
 Sq.Ft./Ctn: 192  
 lbs/Ctn: 58  
 Ctns/Skid: 30  
 lbs/Skid: 1,740

# SOFFIT

## ACCESSORIES



### SNAP-ON FRIEZE TRIM PRODUCT CODE 1072-\_\_

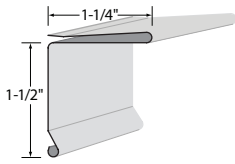

Length: 12'  
 Thickness: 28 Ga.  
 Pieces/Ctn: 25  
 lbs/Ctn: 72

### J-CHANNEL - 7/16" PRODUCT CODE 1028-\_\_



Length: 12'  
 Thickness: .019"  
 Pieces/Ctn: 25  
 lbs/Ctn: 19  
 Ctns/Skid: 56  
 lbs/Skid: 1,064

### MITRE MOULDING PRODUCT CODE 1200-\_\_

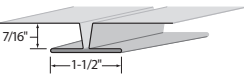

Length: 12'  
 Thickness: .019"  
 Pieces/Ctn: 15  
 lbs/Ctn: 15

### F-CHANNEL (REVERSIBLE) PRODUCT CODE 1191-\_\_

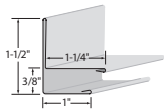

Length: 12'  
 Thickness: .019"  
 Pieces/Ctn: 25  
 lbs/Ctn: 32  
 Ctns/Skid: 56  
 lbs/Skid: 1,792

| Product Code            | 1028 | 1072 | 1191 | 1200 |  |
|-------------------------|------|------|------|------|--|
| Polar White (001)       | ●    | ●    | ●    | ●    |  |
| Almond Cream (702)      | ●    |      | ●    | ●    |  |
| Antique Parchment (715) | ●    | ●    | ●    | ●    |  |
| Black (711)             | ●    | ●    | ●    | ●    |  |
| Canyon (786)            | ●    | ●    | ●    | ●    |  |
| Cedarwood (735)         | ●    | ●    | ●    |      |  |
| Charcoal Gray (728)     | ●    | ●    | ●    | ●    |  |
| Classic Red (727)       | ●    | ●    | ●    |      |  |
| Claytone (709)          | ●    | ●    | ●    | ●    |  |
| Colonial White (720)    | ●    | ●    | ●    | ●    |  |
| Cool Atlantic (731)     |      | ●    |      |      |  |
| Deep Ocean (724)        |      | ●    |      |      |  |
| Desert Tone (718)       | ●    | ●    | ●    | ●    |  |
| Driftwood Gray (726)    | ●    | ●    | ●    |      |  |
| Glacier White (714)     | ●    | ●    | ●    | ●    |  |
| Hartford Green (706)    | ●    |      | ●    | ●    |  |
| Iron Gray (719)         | ●    | ●    | ●    | ●    |  |
| Mahogany (785)          | ●    | ●    | ●    |      |  |
| Midnight* (1111)        | ●    | ●    | ●    | ●    |  |
| Royal Brown (703)       | ●    | ●    | ●    | ●    |  |
| Rustic Brown (722)      | ●    | ●    | ●    | ●    |  |
| Sand Beige (721)        | ●    | ●    | ●    |      |  |
| Sandtone (712)          | ●    | ●    | ●    | ●    |  |
| Stat Bronze (713)       | ●    | ●    | ●    | ●    |  |
| Still Harbor (738)      |      | ●    |      |      |  |
| Timber (736)            | ●    | ●    | ●    |      |  |
| T-Tone (708)            | ●    | ●    | ●    | ●    |  |
| Wickertone (717)        | ●    | ●    | ●    | ●    |  |

\*Midnight is SMP (ENTEX® without the texture).

★ New product for 2026.

# SOFFIT

## ACCESSORIES



**DRIP EDGE: QUICK START STEEL** **PRODUCT CODE**  
**1178-\_\_**

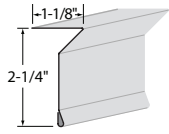

**Polar White 1179-001**

Length: 12'  
Thickness: 28 Ga.  
Pieces/Ctn: 25  
lbs/Ctn: 64

**DRIP EDGE: STYLE D STEEL** **PRODUCT CODE**  
**1177-\_\_**

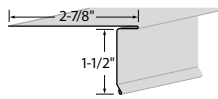

Length: 10'  
Thickness: 28 Ga.  
Pieces/Ctn: 25  
lbs/Ctn: 70  
Ctns/Skid: 40  
lbs/Skid: 2,800

**DRIP EDGE: STYLE D ALUMINUM** **PRODUCT CODE**  
**1171-\_\_**

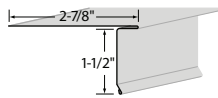

Length: 12'  
Thickness: .019"  
Pieces/Ctn: 25  
lbs/Ctn: 30

**PASLODE LITE LINE SOFFIT STAPLER** **PRODUCT CODE**  
**N18-125 3502-000**



| Product Code            | 1171 | 1177 | 1178 |  |
|-------------------------|------|------|------|--|
| Polar White (001)       | ●    | ●    |      |  |
| Almond Cream (702)      | ●    | ●    | ●    |  |
| Antique Parchment (715) | ●    | ●    | ●    |  |
| Black (711)             | ●    | ●    | ●    |  |
| Canyon (786)            | ●    | ●    | ●    |  |
| Cedarwood (735)         |      | ●    | ●    |  |
| Charcoal Gray (728)     | ●    | ●    | ●    |  |
| Classic Red (727)       |      | ●    | ●    |  |
| Claytone (709)          | ●    | ●    | ●    |  |
| Colonial White (720)    |      | ●    | ●    |  |
| Desert Tone (718)       | ●    | ●    | ●    |  |
| Driftwood Gray (726)    |      | ●    | ●    |  |
| Glacier White (714)     |      | ●    | ●    |  |
| Hartford Green (706)    | ●    | ●    | ●    |  |
| Iron Gray (719)         | ●    | ●    | ●    |  |
| Mahogany (785)          |      | ●    | ●    |  |
| Midnight* (1111)        | ●    | ●    | ●    |  |
| Royal Brown (703)       | ●    | ●    | ●    |  |
| Rustic Brown (722)      | ●    | ●    | ●    |  |
| Sand Beige (721)        |      | ●    | ●    |  |
| Sandtone (712)          | ●    | ●    | ●    |  |
| Stat Bronze (713)       | ●    | ●    | ●    |  |
| Timber (736)            |      | ●    | ●    |  |
| T-Tone (708)            | ●    | ●    | ●    |  |
| Wickertone (717)        | ●    | ●    | ●    |  |

\*Midnight is SMP (ENTEX® without the texture).

# FASCIA

## STEEL



**4" - 10' FASCIA** **PRODUCT CODE**  
**1194-\_\_**

Length: 10'  
 Thickness: 28 Ga.  
 Pieces/Ctn: 20  
 lbs/Ctn: 60  
 Ctns/Skid: 25  
 lbs/Skid: 1,500

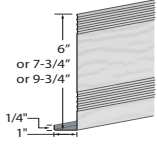

Woodgrain with ribs.

**6" - 10' FASCIA** **PRODUCT CODE**  
**1192-\_\_**

Length: 10'  
 Thickness: 28 Ga.  
 Pieces/Ctn: 20  
 lbs/Ctn: 85  
 Ctns/Skid: 60  
 lbs/Skid: 5,100

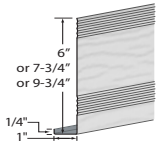

Woodgrain with ribs.

**6" - 12' FASCIA** **PRODUCT CODE**  
**1193-\_\_**

Length: 12'  
 Thickness: 28 Ga.  
 Pieces/Ctn: 20  
 lbs/Ctn: 102

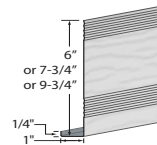

Woodgrain with ribs.

**8" - 10' FASCIA** **PRODUCT CODE**  
**1198-\_\_**

Length: 10'  
 Thickness: 28 Ga.  
 Pieces/Ctn: 20  
 lbs/Ctn: 106  
 Ctns/Skid: 40  
 lbs/Skid: 4,240

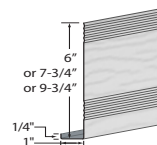

Woodgrain with ribs.

**10" - 10' FASCIA** **PRODUCT CODE**  
**1195-\_\_**

Length: 10'  
 Thickness: 28 Ga.  
 Pieces/Ctn: 12  
 lbs/Ctn: 80

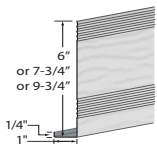

Woodgrain with ribs.

| Product Code            | 1192 | 1193 | 1194 | 1195 | 1198 |
|-------------------------|------|------|------|------|------|
| Polar White (001)       | ●    | ●    | ●    | ●    | ●    |
| Almond Cream (702)      | ●    |      |      | ●    | ●    |
| Antique Parchment (715) | ●    |      |      | ●    | ●    |
| Black (711)             | ●    |      |      | ●    | ●    |
| Canyon (786)            | ●    |      |      | ●    | ●    |
| Cedarwood (735)         | ●    |      |      | ●    | ●    |
| Charcoal Gray (728)     | ●    |      |      | ●    | ●    |
| Classic Red (727)       | ●    |      |      | ●    | ●    |
| Claytone (709)          | ●    |      |      | ●    | ●    |
| Colonial White (720)    | ●    |      |      |      | ●    |
| Desert Tone (718)       | ●    |      |      | ●    | ●    |
| Driftwood Gray (726)    | ●    |      |      | ●    | ●    |
| Glacier White (714)     | ●    |      |      | ●    | ●    |
| Hartford Green (706)    | ●    |      |      | ●    | ●    |
| Iron Gray (719)         | ●    |      |      | ●    | ●    |
| Mahogany (785)          | ●    |      |      | ●    | ●    |
| Midnight* (1111)        | ●    |      |      | ●    | ●    |
| Royal Brown (703)       | ●    |      |      | ●    | ●    |
| Rustic Brown (722)      | ●    |      |      | ●    | ●    |
| Sand Beige (721)        | ●    |      |      |      | ●    |
| Sandtone (712)          | ●    | ●    |      | ●    | ●    |
| Statuary Bronze (713)   | ●    |      |      | ●    | ●    |
| Timber (736)            | ●    |      |      | ●    | ●    |
| T-Tone (708)            | ●    |      |      | ●    | ●    |
| Wickertone (717)        | ●    |      |      | ●    | ●    |

\*Midnight is SMP (ENTEX® without the texture).

# FASCIA

## ALUMINUM, SMOOTH ▶▶▶

**PRODUCT CODE**

---

**4" FASCIA** **1140-001**



Length: 12'

Thickness: .024"

Pieces/Ctn: 25

lbs/Ctn: 50

Smooth with ribs.

---

**6" FASCIA** **1141-\_\_**



Length: 12'

Thickness: .024"

Pieces/Ctn: 25

lbs/Ctn: 67

Smooth with ribs.

---

**8" FASCIA** **1142-\_\_**



Length: 12'

Thickness: .024"

Pieces/Ctn: 25

lbs/Ctn: 83

Smooth with ribs.

---

**10" FASCIA** **1143-\_\_**



Length: 12'

Thickness: .024"

Pieces/Ctn: 25

lbs/Ctn: 100

Smooth with ribs.

| Product Code            | 1140 | 1141 | 1142 | 1143 |  |
|-------------------------|------|------|------|------|--|
| Polar White (001)       | ●    | ●    | ●    | ●    |  |
| Almond Cream (702)      |      | ●    | ●    | ●    |  |
| Antique Parchment (715) |      | ●    | ●    | ●    |  |
| Black (711)             |      | ●    | ●    | ●    |  |
| Canyon (786)            |      | ●    | ●    | ●    |  |
| Charcoal Gray (728)     |      | ●    | ●    | ●    |  |
| Claytone (709)          |      | ●    | ●    | ●    |  |
| Desert Tone (718)       |      | ●    | ●    | ●    |  |
| Hartford Green (706)    |      | ●    | ●    | ●    |  |
| Iron Gray (719)         |      | ●    |      |      |  |
| Midnight* (1111)        |      | ●    | ●    | ●    |  |
| Royal Brown (703)       |      | ●    | ●    | ●    |  |
| Rustic Brown (722)      |      | ●    | ●    | ●    |  |
| Sandtone (712)          |      | ●    | ●    | ●    |  |
| Statuary Bronze (713)   |      | ●    | ●    | ●    |  |
| T-Tone (708)            |      | ●    | ●    | ●    |  |
| Wickertone (717)        |      | ●    | ●    | ●    |  |

\*Midnight is SMP (ENTEX® without the texture).

# FASCIA

## ALUMINUM, WOODGRAIN



**4" FASCIA** **PRODUCT CODE**  
**1130-\_\_**

Length: 12'  
Thickness: .024"  
Pieces/Ctn: 25  
lbs/Ctn: 50



Woodgrain with no ribs.

**6" FASCIA** **PRODUCT CODE**  
**1131-\_\_**

Length: 12'  
Thickness: .024"  
Pieces/Ctn: 25  
lbs/Ctn: 67



Woodgrain with no ribs.

**8" FASCIA** **PRODUCT CODE**  
**1132-\_\_**

Length: 12'  
Thickness: .024"  
Pieces/Ctn: 25  
lbs/Ctn: 83



Woodgrain with no ribs.

**10" FASCIA** **PRODUCT CODE**  
**1133-\_\_**

Length: 12'  
Thickness: .024"  
Pieces/Ctn: 25  
lbs/Ctn: 100



Woodgrain with no ribs.

| Product Code            | 1130 | 1131 | 1132 | 1133 |  |
|-------------------------|------|------|------|------|--|
| Polar White (001)       | ●    | ●    | ●    | ●    |  |
| Almond Cream (702)      |      | ●    | ●    | ●    |  |
| Antique Parchment (715) |      | ●    | ●    | ●    |  |
| Black (711)             |      | ●    | ●    | ●    |  |
| Canyon (786)            |      | ●    | ●    | ●    |  |
| Charcoal Gray (728)     |      | ●    | ●    | ●    |  |
| Claytone (709)          |      | ●    | ●    | ●    |  |
| Desert Tone (718)       |      | ●    | ●    | ●    |  |
| Hartford Green (706)    |      | ●    | ●    | ●    |  |
| Iron Gray (719)         |      | ●    | ●    | ●    |  |
| Midnight* (1111)        |      | ●    | ●    | ●    |  |
| Royal Brown (703)       |      | ●    | ●    | ●    |  |
| Rustic Brown (722)      |      | ●    | ●    | ●    |  |
| Sandtone (712)          |      | ●    | ●    | ●    |  |
| Statuary Bronze (713)   |      | ●    | ●    | ●    |  |
| T-Tone (708)            |      | ●    | ●    | ●    |  |
| Wickertone (717)        |      | ●    | ●    | ●    |  |

\*Midnight is SMP (ENTEX® without the texture).

# FASCIA

## ACCESSORIES



**PRODUCT CODE**  
**MAZE DOUBLE HOT-DIPPED GALVANIZED TRIM NAILS**      **3278-\_\_\_**  
 Length: 1-1/2"  
 lbs/Ctn: 1



**PRODUCT CODE**  
**MAZE PAINTED STAINLESS STEEL TRIM NAILS**      **3279-\_\_\_**  
 Length: 1-1/2"  
 lbs/Ctn: 1



| Product Code            | 3278 | 3279 |  |
|-------------------------|------|------|--|
| Polar White (001)       | ●    | ●    |  |
| Antique Parchment (715) | ●    | ●    |  |
| Black (711)             | ●    | ●    |  |
| Canyon (786)            | ●    | ●    |  |
| Cedarwood (735)         | ●    | ●    |  |
| Charcoal Gray (728)     | ●    | ●    |  |
| Classic Blue (707)      | ●    | ●    |  |
| Classic Red (727)       | ●    | ●    |  |
| Claytone (109)          | ●    | ●    |  |
| Colonial White (001)    | ●    | ●    |  |
| Deep Ocean (724)        | ●    | ●    |  |
| Desert Tone (718)       | ●    | ●    |  |
| Driftwood Gray (726)    | ●    | ●    |  |
| Glacier White (714)     | ●    | ●    |  |
| Heritage Gray (010)     | ●    | ●    |  |
| Hartford Green (792)    | ●    | ●    |  |
| Iron Gray (719)         | ●    | ●    |  |
| Mahogany (785)          | ●    | ●    |  |
| Midnight (711)          | ●    | ●    |  |
| Royal Brown (703)       | ●    | ●    |  |
| Sage (790)              | ●    | ●    |  |
| Sandtone (109)          | ●    | ●    |  |
| Sand Beige (721)        | ●    | ●    |  |
| Statuary Bronze (713)   | ●    | ●    |  |
| Timber (736)            | ●    | ●    |  |
| T-Tone (708)            | ●    | ●    |  |
| Wickertone (717)        | ●    | ●    |  |
| Willow (792)            | ●    | ●    |  |

# PERSPECTIVES SPECIFICATIONS

---



## TECHNICAL DATA

Substrate: Roll-formed, CS Type B - 0.02" (nominal) thick G90 hot-dipped galvanized steel complying with ASTM A653

Application: Wall, soffit

Minimum Ultimate Tensile Strength: Complies with ASTM A653

Minimum Ultimate Yield Strength: 33,000–55,000 psi

Minimum Elongation: >20%

Modulus of Elasticity: 30

Coefficient of Linear Expansion: 6.7 u-in/in/°F

Melting Range: 2600°F

Thickness: 0.02", 26ga

Coating:

Woodgrain Finish: Electron-beam-cured proprietary inkjet print at 400dpi

Solid Color Finish: Silicone Modified Polyester

Fastening System: Concealed

Warranty: 20-year limited warranty

## MATERIAL DATA

100% Recyclable

Recycled Content: Up to 80%

VOC Free

Lead Free

## DIMENSIONS

Panel Length: 12'

Panel Coverage: 4", 6"

Panel Depth: 0.75"

Ventilation Openings: 0.156 x 0.375

Ventilation Intervals: 1.375"

Ventilation Maximum:

- Tight/Flush: 1.2 sq.in/Lft
- Slight/Nickel Gap: 1.4 sq.in/Lft

Course Spacing:

- 0.1" (flush/tight)
- 0.3" (slight/nickel gap)

## WARRANTY

Please refer to our Warranty page on our website. Visit [www.edcoproducts.com/support/warranty.html](http://www.edcoproducts.com/support/warranty.html).

# ENDURA SPECIFICATIONS



## GENERAL CHARACTERISTICS

EDCO Steel-Kore® steel siding is intended for sidewall installation on residential or commercial exterior applications in new construction or remodeling with or without sheathing type or drop in insulation or underlayment. Siding to be manufactured with an embossed finish. The ENTEX® finish has Cool Chemistry pigments in it so it meets EnergyStar® requirements.

## MATERIAL SPECIFICATIONS - METAL

EDCO Steel-Kore® steel siding and steel siding accessories shall be coated with an ENTEX® finish and made with CS Type B steel of the specified color and texture fabricated from nominal 28 gauge galvanized steel coil, with both sides zinc-coated by the continuous hot dipped galvanizing method.

Tensile Strength (PSI) . . . . 50,000

Yield Strength (PSI) . . . 35,000

All material conforms to ASTM A653/A653M-05.

- A.) Clapboards shall provide 6", 8", Double 4" and Double 5" Dutchlap exposure and shall be furnished in lengths calculated to total 100 square feet exposed area per carton. The product shall be formed at the factory with a nailing flange to interlock securely with successive courses.
- B.) Vertical siding to be formed at the factory with a board and batten appearance having a batten width of approximately 2" and standard widths of 12" calculated to a total 100 square feet of exposure area per carton.

## MATERIAL SPECIFICATIONS - PAINT

EDCO Steel-Kore® steel siding shall be in accordance with EDCO manufacturing specifications including:

- Paint preparation: Both sides chemically cleaned with an alkaline "Henkel 8686" cleaner.  
Dry in place chrome conversion coating with Henkel "Bonderite 1402W" applied to both sides.
- ENTEX® Paint System: Prime Coat – AkzoNobel's 60000 Universal corrosion-resistant Primer.  
Top Coat – AkzoNobel's CERAM-A-STAR® 1050 with Akzo's Cool Chemistry pigments, average film thickness 1.0 mil.  
HD Imaging – AkzoNobel's specialty formulated top coat finish.  
Back Coat – Kel Coatings waterbase or a polyester composition corrosion-resisting backer.

## MANUFACTURING

- Panel:
  - A. 8" exposure x 12'6" long, 9/16" butt
  - B. Double 4" exposure x 12'6" long, 1/2" butt
  - C. Double 5" Dutchlap exposure 12'0" long, 9/16" butt
  - D. 6" exposure x 12'6" long, 1/2" butt
  - E. Vertical 12" exposure x 10'0" long, 9/16" batten butt
- Packed:
  - D4" and 8" - 12 pcs. (100 sq. ft.) per carton
  - D5" Dutchlap - 10 pcs. (100 sq. ft.) per carton
  - 6" - 16 pcs. (100 sq. ft.) per carton
  - Vertical - 10 pcs. (100 sq. ft.) per carton

All accessories shall be color matched to be visually similar in all respects to the color of the steel siding or panel unless otherwise specified. Manufacturer's warranty is not valid unless EDCO Steel-Kore® siding accessories, where applicable to the job, are used.

## WARRANTY

Please refer to our Warranty page on our website. Visit [www.edcoproducts.com/support/warranty.html](http://www.edcoproducts.com/support/warranty.html).

# ARROWLINE SPECIFICATIONS



| <b>RATING</b>  | <b>RESULTS</b>   |
|--|--|
| FM-4470 Foot Traffic/Hail Resistance                 | Is resistant to severe hail and foot traffic   |
| UL – 1897 Uplift Resistance                          | Up to 160 mph rating with 5 clips and screws   |
| UL – 2218 Hail / Impact Resistance                   | Class 4 rating (Highest possible rating)   |
| TX Department of Insurance                           | RC-170 (Shake)   |
| Canadian Construction Materials Centre               | CCMC 13380-R (Both)  |
| ICC-ES Evaluation Report                             | ESR-3564   |
| ICBO AC07 Penetration Resistance                     | 200 lbs pressure, minimum deformation  |
| ASTM A653  | Galvanization by hot-dip process   |
| UL – 790 Fire Resistance                             | Class A over Densdeck or Versashield<br>Class C over 30# felt paper  |
| Florida Building Code # FL 4077                      | Hurricane Testing  |
| Coating Performance (Testing performed by AkzoNobel) |  |
| ASTM D – 3361 Accelerated Weathering                 | Hours: 1000<br>Chalk: Rating 8<br>Color: 5ΔE Hunter units maximum  |
| ASTM B – 117 Salt Spray                              | Hours: 1000 hours<br>Scribe Rating: 7, 1/16"<br>Field: Rating 10, no adhesion loss or blisters   |
| ASTM D – 2247 Humidity                               | Hours: 1500 hours<br>Rating: 10, no blisters, cracking, or softening   |
| ASTM D – 4145 Formability                            | 0T to 1T   |
| ASTM D – 3363 Pencil Hardness                        | F to H   |
| ASTM D – 2794 Reverse Impact                         | 80 lbs with no loss of adhesion  |
| ASTM D – 523 Specular Gloss                          | 8 – 12% at 60°   |
| ASTM D-522   | No loss of adhesion (Elongation over 1/8" Cylindrical mandrel)   |
| ASTM E – 84 Flame hazard test                        | Class A / Class 1 coating  |
| ASTM D – 5402 Cure test                              | 100 rubs   |
| Material Specifications                              |  |
| Gauge: Shake   | 28 & 30 Gauge Painted Galvanized Steel   |
| Gauge: Slate   | 28 Gauge Painted Galvanized Steel  |
| Minimum Slope:                                       | 4" in 12"  |
| Panel Exposure Area:                                 | 12" x 50"  |
| Panel Coverage:                                      | 4.17 sq. ft. / panel   |
| Panels Per Box:                                      | 12 panels (50 sq. ft. / box)   |
| Weight: Shingle - Shake                              | 37 lbs / box (74 lbs/sq. approx.)  |
| Weight: Slate  | 47 lbs / box (94 lbs/sq. approx.)  |
| Clip Material:                                       | .0024" Galvanized Steel  |
| Shingle Material:                                    | Nominal 0.0135" thickness, including G90 galvanization and paint coating. Exterior finish is TRINAR 70% PVDF Fluoropolymer, 1 mil thickness, with anti-corrosive primer. Interior finish is a wash coat. |
| Slate Material:                                      | Nominal 0.0160" thickness, including G90 galvanization and paint coating. Exterior finish is TRINAR 70% PVDF Fluoropolymer, 1 mil thickness, with anti-corrosive primer. Interior finish is a wash coat. |

# SOFFIT & FASCIA SPECIFICATIONS



## GENERAL CHARACTERISTICS

EDCO Aluma-Kore® Aluminum Quad soffit system is intended for exterior overhang installations on residential or commercial buildings. Available in Enamel, ENTEX® and PVC Finishes.

## MATERIAL SPECIFICATIONS

|                |   |   |
|----------------|---|---|
| Soffit – Metal | Nominal .019" thick aluminum, alloy 3105, hardness/temper H-15.   |   |
| Fascia – Steel | Nominal 28 gauge galvanized steel, Zinc coated by the continuous hot dipped galvanizing method. Conforms to ASTM A653/A653M-05. |   |
|                | Aluminum Tensile Strength (PSI): 26,000 <sup>1</sup>  | Aluminum Yield Strength (PSI): 25,000 <sup>1</sup>  |
|                | Aluminum Ult Sheer Strength (PSI): 15,000   | Aluminum Endurance Limit (PSI): 10,000 <sup>1</sup> |
|                | Steel Tensile Strength (PSI): 50,000  | Steel Yield Strength (PSI): 35,000 <sup>1</sup>     |

## MATERIAL PAINT SPECIFICATIONS

|                      |  |
|----------------------|--|
| Paint Preparation:   | Both sides of substrate chemically cleaned with an alkaline "Henkel 8686" cleaner.<br>Dry in place chrome conversion coating with Henkel "1402W Bonderite" applied to both sides of substrate.   |
| Enamel Paint System: | Prime Coat – AkzoNobel's 60000 Universal corrosion-resistant primer (no primer is used on aluminum.)<br>Top Coat – Kel Coatings or AkzoNobel polyester enamel.<br>Back Coat – Kel Coatings waterbase or a polyester composition corrosion-resisting backer.                        |
| PVC Paint System:    | Prime Coat – Valspar Plastisol corrosion resistant primer.<br>Top Coat – Valspar striated vinyl Plastisol, average film thickness 4.0 mil.<br>Back Coat – Kel Coatings waterbase or a polyester composition corrosion-resisting backer.  |
| ENTEX Paint System:  | Prime Coat – AkzoNobel's 60000 Universal corrosion-resistant Primer<br>Top Coat – AkzoNobel's CERAM-A-STAR® 1050 with Akzo's Cool Chemistry pigments, average film thickness 1.0 mil.<br>Back Coat – Kel Coatings waterbase or a polyester composition corrosion-resisting backer. |

## MANUFACTURING SPECIFICATIONS

|                     |  |
|---------------------|--|
| Soffit Panel:       | A. Quad Soffit (16" width x 12'0" length)<br>1) Packed 12 pcs./carton, 192 sq. ft.<br>2) Net Free Airflow<br>Center Vent: 6.48 sq. in./Lft. of panel<br>B. Tri Soffit (12" width x 12'0" length)<br>1) Packed 16 pcs./carton, 192 sq. ft.<br>2) Net Free Airflow<br>Center Vent: 3.2 sq. in./Lft. of panel<br>Full Vent: 12.96 sq.in./Lft of panel |
| Steel Fascia Panel: | A. 4", 6", 8" and 10" wide x 10'0" long with stiffening ribs & woodgrain texture.<br>1) 4", 6", and 8" packed 20 pcs./carton, 200 lineal feet<br>Polyester Enamel, ENTEX & PVC Finishes<br>2) 10" packed 12 pcs./carton, 120 lineal feet<br>Polyester Enamel, ENTEX & PVC Finishes   |

All materials conform to QQ-A-250/2

All procedures, operations and specifications shall meet or exceed EDCO Quality Control Standard Procedures, including ICBO, BOCA and SBCC.

# GUTTER & RAINWARE SPECIFICATIONS

---



## GENERAL CHARACTERISTICS

Aluma-Kore® Aluminum Gutter system is intended for exterior overhang installations on residential or commercial buildings. Available in Enamel and ENTEX® Finishes.

## MATERIAL SPECIFICATIONS

Gutter – Metal                      Nominal .032" thick aluminum (All finishes), alloy 3105, hardness/temper H-15

Aluminum Tensile Strength (PSI): 26,000<sup>1</sup>      Aluminum Yield Strength (PSI): 25,000<sup>1</sup>  
Aluminum Ult Sheer Strength (PSI): 15,000<sup>1</sup>      Aluminum Endurance Limit (PSI): 10,000<sup>1</sup>

## MATERIAL PAINT SPECIFICATIONS

Paint Preparation:                      Both sides of substrate chemically cleaned with an alkaline "Henkel 8686" cleaner.  
Dry in place chrome conversion coating with Henkel "1402W Bonderite"  
applied to both sides of substrate.

Enamel Paint System:                      Prime Coat – AkzoNobel's 60000 Universal corrosion-resistant primer. (No primer is  
used on aluminum.)  
Top Coat – Kel Coatings or AkzoNobel polyester enamel.  
Back Coat – Kel Coatings waterbase or a polyester composition corrosion-resisting backer.

ENTEX Paint System:                      Prime Coat – AkzoNobel's 60000 Universal corrosion-resistant Primer or Valspar.  
Top Coat – AkzoNobel's CERAM-A-STAR® 1050 with Akzo's Cool Chemistry  
pigments, average film thickness or Weather XL.  
Back Coat – Kel Coatings .07 waterbase or a polyester composition corrosion-  
resisting backer.

## MANUFACTURING SPECIFICATIONS

Gutter:    A) Standard K style, 5" width, custom lengths

All materials conform to QQ-A-250/2.

All procedures, operations and specifications shall meet or exceed EDCO® Quality Control Standard Procedures, including ICBO, BOCA and SBCC.

# NOTES



A series of horizontal black lines providing a template for writing notes. The lines are evenly spaced and extend across the width of the page.

# NOTES



Lined area for notes with 19 horizontal lines.

# SAVE TIME!

PLACE ALL YOUR ORDERS ON THE EDCO PORTAL.

[edcoportal.com](https://edcoportal.com)

Your online resource for all of your EDCO business needs.

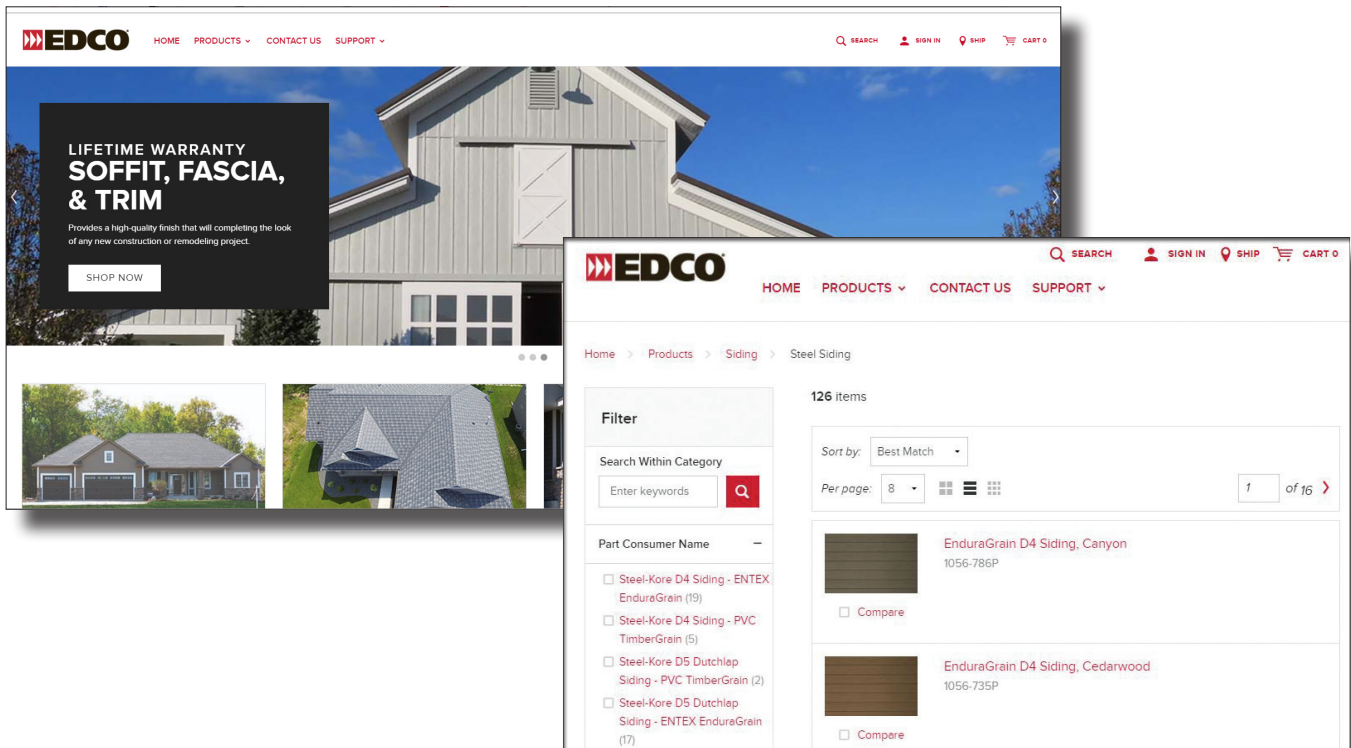

Here are some of the things you can access through the portal:

- Place Orders 24/7/365
- Track Shipments
- View Invoices
- Find Real-time Pricing
- Check Inventory
- So Much More

**Don't have an account yet?**  
**Give us a call and we can get you started!**

Shop EDCO's high-performance product lines



T-Tone Blend, Slate

**ABOUT EDCO** With over 75 years of trusted expertise and an unwavering commitment to excellence, EDCO Products combines elevated design and exceptional craftsmanship, delivering premium Siding, Roofing, Soffit, Fascia, Trim, and Rainware products that are as beautiful as they are durable.



800.593.2680 | [edcoproducts.com](http://edcoproducts.com) | © EDCO Products Inc.